



03



SOCKET ASSORTMENTS



Socket Assortments 1/4" _____	Page 136
Socket Assortments 3/8" _____	Page 145
Socket Assortments 1/2" _____	Page 157
Socket Assortments 3/4" _____	Page 190
Socket Assortments 1" _____	Page 200

Whether you work in precision mechanics or heavy industry, hardly any production facility or workshop today can get by without socket wrenches. And the range of sockets and socket wrenches available from ELORA reflects this broad spectrum of applications. Tradesmen and women appreciate the absolutely dependable quality and the excellent design which ensure long tool lifetimes even under heavy loads. To make certain that this precision tool meets all the requirements expected in industrial environments, a series of production steps are required, as we explain here.

You will be impressed by the amount of effort our tool experts put into every tool we make up to the point where it is ready for worldwide shipment and sold to a satisfied customer. This applies to all our products – whether it is a single tool or a complete, carefully compiled tool set.

As with all ELORA product families, we place great store by ensuring consistently high product quality, which is why the tight quality controls we apply after every operation have been standard procedure here for some time.

You can expect really tough ratchets that will never let you down – a result of our hand-picked raw materials and sophisticated manufacturing processes. And, to match, we have numerous different sockets and types of sockets. Our impressive product range includes TORX®, multipoint-head, internal hex drive, slotted and Phillips / Pozidriv – you get exactly what you need.

In conclusion – when you buy an ELORA ratchet, you are buying a particularly high-quality tool. Included in the price is the satisfaction of knowing that you have bought a piece of high-grade German engineering – workmanship that is worth every cent.



The inherent qualities of ELORA ratchets are also very impressive. The fine-toothed precision-made gearing that ensures concentricity and maximum functionality. The individual production steps leading up to the “marriage” of outer body and inner mechanisms all require extensive know-how coupled with an enthusiastic attention to detail.

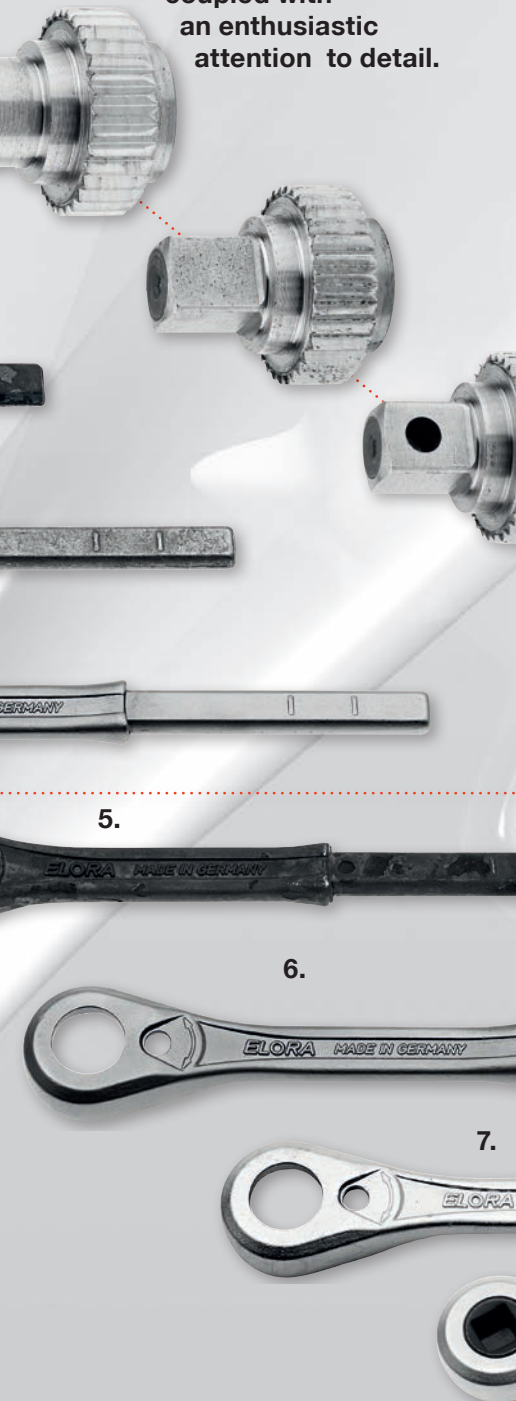

1. Blanking

The starting material is high-grade ELORA chrome vanadium 31 CrV3/1.2208.

2. Hot forging & flash removal

- a. The cropped blank is heated in a furnace to the correct forging temperature and then drop forged in this hot state using high press forces.
- b. Following this, the flash is then removed using flash-removal presses.

3. Grinding & vibro-deburring

The subsequent grinding process ensures the tool has a smooth outside surface. Any sharp edges and flash still remaining are then removed by vibro-deburring.

4. CNC machining

The internal shaping of the ratchet head is machined exactly to size in a machining centre.

5. Hardening and tempering

This special heat treatment ensures the longest possible service lifetimes. The tool's tensile strength is provided by precise hardening to a given temperature and the high level of ductility by the tempering process.

6. Sand blasting

To make sure the ratchet has a matt, non-slip surface, we sand-blast it.

7. Electroplating

The surface is given durable anti-corrosion protection and a high-quality satin-finish appearance.

8. “Marriage” & final assembly

This process involves bringing together the body and internal mechanisms. The handle, internal mechanisms and cover are fitted. The tool's functionality is thoroughly checked.

5.

6.

7.

8.

If ELORA customers want to get the full benefit of an ELORA ratchet, they really need sockets of the same high quality. As you would expect, the manufacture of these sockets is subject to the same stringent quality requirements and ELORA sockets are also hot forged.

This creates a microscopic fibre-like structure in the metal with no interruptions (in contrast to cold-formed tools) which always runs parallel to the outer shape. Unwanted stresses in the tool are thus kept to an absolute minimum. At the same time, this increases the tool's durability and tensile strength by a considerable degree – these are product benefits that pay for themselves, especially when you are applying full loadings, and enable long service lives.

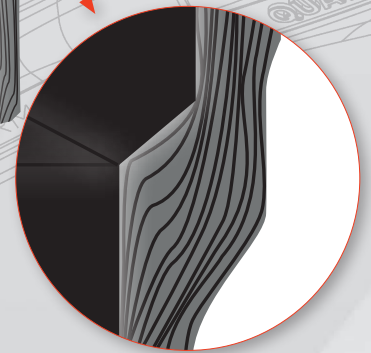
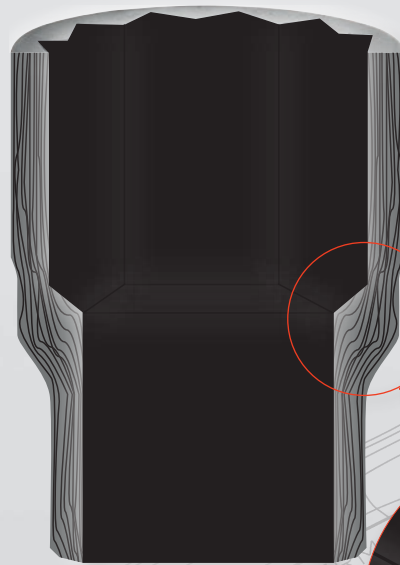

One advantage of hot forging: the uninterrupted fibre-like structure

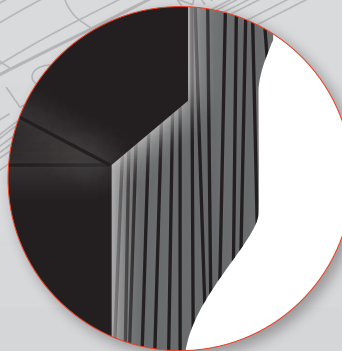

The disadvantage of cold-forming: interrupted fibres

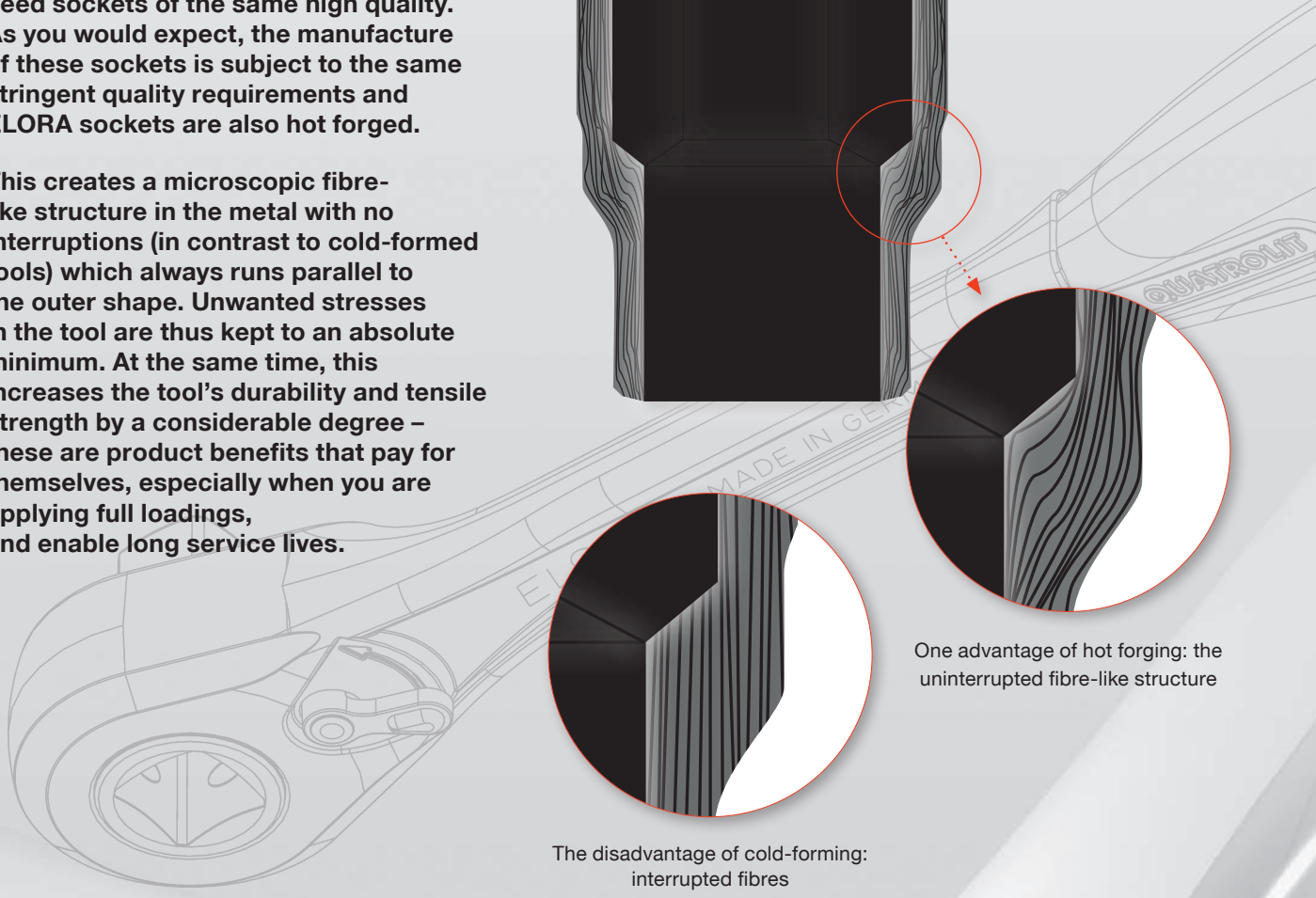

03

This ELORA product family contains a wide range of sockets designed for all sectors of industry and the trades. Input and output drives for many different types of sockets. All the standard sizes you would expect. Separately or in sets. In robust, protective metal cases or ready for use in exactly cut, easy-to-use ELORA OMS modules.



The production process for ELORA sockets is both costly and complex

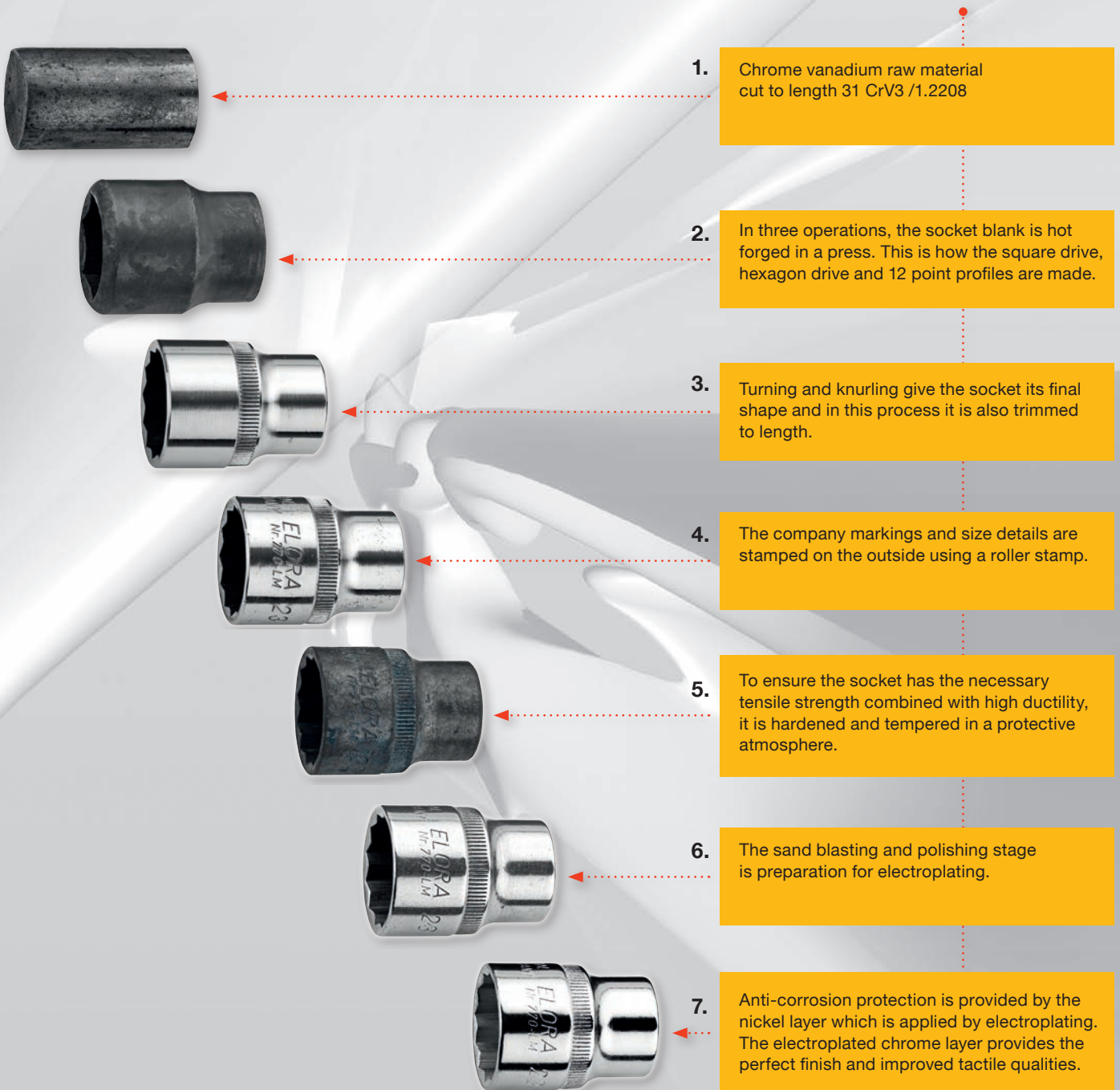

1450-1D
REVERSIBLE RATCHET 1/4", FINE TOOTH

- with small, slim head
- gear wheel with safety locking and quick release button
- smallest possible swivel angle 5°
- nonslip QUATROLIT®-2C-handle
- with suspension hole
- matt chrome-plated
- ELORA-Chrome-Vanadium 31CrV3 / 1.2208
- male square according to DIN 3120-A 6,3, ISO 1174, with ball locking device
- according to DIN 3122, ISO 3315

6,3
1/4"

Code	Number	l/mm	Pieces	Weight/g
1450000012200	1450-1D	145	1	104
1450000012003	1450-E1D	Repair Kit	1	20

1450-1UN
REVERSIBLE RATCHET 1/4", FINE TOOTH

- with small, round head
- forged, fine toothed wheel with grippy metal switching disk
- smallest possible swivel angle 5°
- nonslip QUATROLIT®-2C-handle
- with suspension hole
- matt chrome-plated
- ELORA-Chrome-Vanadium 31CrV3 / 1.2208
- male square according to DIN 3120-A 6,3, ISO 1174, with ball locking device
- according to DIN 3122, ISO 3315

6,3
1/4"

Code	Number	l/mm	Pieces	Weight/g
1450000013900	1450-1UN	145	1	121
1450000012012	1450-E1UN	Repair Kit	1	35

1450-2ZI
PUSH THROUGH RATCHET 1/4"

- extremely rugged ratchet with round head
- forged gear wheel with push through square coupler
- smallest possible swivel angle 18°
- nonslip QUATROLIT®-2C-handle
- matt chrome-plated
- ELORA-Chrome-Vanadium 31 CrV 3 / 1.2208
- square according to DIN 3120-A 6,3, ISO 1174, with ball locking device
- according to DIN 3122, ISO 3315



1450-2V

6,3
1/4"

Code	Number	l/mm	Pieces	Weight/g
1450000022000	1450-2ZI	145	1	89
1450000022001	1450-E2ZI	Repair Kit	1	20
1450000022002	1450-2V	21	1	8

You will find the matching socket converter 1/4" on page no. 141

1455-M..., 1455A-...

SOCKET 1/4", HEXAGON

- matt chrome-plated
- knurled
- ELORA-Chrome-Vanadium 31CrV3 / 1.2208
- female square according to DIN 3120-C 6,3, ISO 1174, with ball retaining groove
- according to DIN 3124, ISO 2725-1



6,3

1/4"



Code	Number	l/mm	Pieces	Weight/g
1455000352000	1455-M 3,5	25	12	9
1455000042000	1455-M 4	25	12	9
1455000452000	1455-M 4,5	25	12	10
1455000052000	1455-M 5	25	12	10
1455000552000	1455-M 5,5	25	12	10
1455000062000	1455-M 6	25	12	10
1455000072000	1455-M 7	25	12	11
1455000082000	1455-M 8	25	12	12
1455000092000	1455-M 9	25	12	14
1455000102000	1455-M 10	25	12	18
1455000112000	1455-M 11	25	12	23
1455000122000	1455-M 12	25	12	24
1455000132000	1455-M 13	25	12	24
1455000142000	1455-M 14	25	12	28

Code	Number	l/mm	Pieces	Weight/g
1455100082000	1455A-5/32	25	12	9
1455100092000	1455A-3/16	25	12	10
1455100112000	1455A-7/32	25	12	10
1455100132000	1455A-1/4	25	12	10
1455100152000	1455A-9/32	25	12	11
1455100172000	1455A-5/16	25	12	12
1455100182000	1455A-11/32	25	12	14
1455100192000	1455A-3/8	25	12	18
1455100212000	1455A-7/16	25	12	23
1455100232000	1455A-1/2	25	12	24
1455100242000	1455A-9/16	25	12	28

03

1455-T...

SOCKET 1/4", HEXAGON, EXTRA DEEP

- matt chrome-plated
- knurled
- ELORA-Chrome-Vanadium 31CrV3 / 1.2208
- female square according to DIN 3120-C 6,3, ISO 1174, with ball retaining groove
- according to DIN 3124, ISO 2725-1



6,3

1/4"



Code	Number	l/mm	Pieces	Weight/g
1455050402000	1455-T 4	50	6	14
1455050452000	1455-T 4,5	50	6	14
1455050502000	1455-T 5	50	6	15
1455050552000	1455-T 5,5	50	6	16
1455050602000	1455-T 6	50	6	17
1455050702000	1455-T 7	50	6	22
1455050802000	1455-T 8	50	6	25
1455050902000	1455-T 9	50	6	29
1455051002000	1455-T 10	50	6	33
1455051102000	1455-T 11	50	6	46
1455051202000	1455-T 12	50	6	51
1455051302000	1455-T 13	50	6	55
1455051402000	1455-T 14	50	6	72

1455-TXE...

SOCKET 1/4"

- for outside TORX® screws
- matt chrome-plated
- knurled
- ELORA-Chrome-Vanadium 31CrV3 / 1.2208
- female square according to DIN 3120-C 6,3, ISO 1174, with ball retaining groove
- TORX® = reg. trademark of Acument Intellectual Properties, LLC. USA



6,3

1/4"



Code	Number	l/mm	l/mm	Pieces	Weight/g
1455060042000	1455-TXE 4	3,86	25	12	12
1455060052000	1455-TXE 5	4,75	25	12	12
1455060062000	1455-TXE 6	5,74	25	12	14
1455060072000	1455-TXE 7	6,22	25	12	14
1455060082000	1455-TXE 8	7,52	25	12	15
1455060102000	1455-TXE 10	9,42	25	12	18
1455060112000	1455-TXE 11	9,98	25	12	18

1455-IS...

SCREWDRIVER SOCKET 1/4"

- for plain slotted screws
- matt chrome-plated
- knurled
- ELORA-Chrome-Vanadium 31CrV3 / 1.2208
- female square according to DIN 3120-C 6,3, ISO 1174, with ball retaining groove
- with manganese-phosphated blade
- tips according to DIN ISO 2380-1 Form B

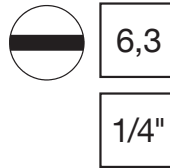

1455-PH...

SCREWDRIVER SOCKET 1/4"

- for cross slotted screws
- matt chrome-plated
- knurled
- ELORA-Chrome-Vanadium 31CrV3 / 1.2208
- female square according to DIN 3120-C 6,3, ISO 1174, with ball retaining groove
- with manganese-phosphated blade
- tips according to DIN ISO 8764-1 PH

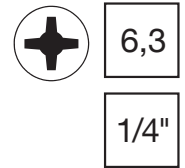

Code	Number	Blade Size mm	l/mm	Pieces	Weight/g
1455020402000	1455-IS 4	0,8 x 4,0	25	12	10
1455020552000	1455-IS 5,5	1,0 x 5,5	25	12	11
1455020652000	1455-IS 6,5	1,2 x 6,5	25	12	11
1455020802000	1455-IS 8	1,6 x 8,0	25	12	11

Code	Number	l/mm	Pieces	Weight/g
1455021012000	1455-PH 1	28	12	11
1455021022000	1455-PH 2	28	12	11
1455021032000	1455-PH 3	28	12	12
1455021042000	1455-PH 4	28	12	13

1455-PZ...

SCREWDRIVER SOCKET 1/4"

- for cross slotted screws
- matt chrome-plated
- knurled
- ELORA-Chrome-Vanadium 31CrV3 / 1.2208
- female square according to DIN 3120-C 6,3, ISO 1174, with ball retaining groove
- with manganese-phosphated blade
- tips according to DIN ISO 8764-1 PZ

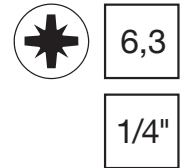

Code	Number	l/mm	Pieces	Weight/g
1455022012000	1455-PZ 1	28	12	10
1455022022000	1455-PZ 2	28	12	11
1455022032000	1455-PZ 3	28	12	12

1455-IN..., 1455-INA...

SCREWDRIVER SOCKET 1/4"

- for inside hexagon screws
- matt chrome-plated
- knurled
- ELORA-Chrome-Vanadium 31CrV3 / 1.2208
- with manganese-phosphated male hexagon
- female square according to DIN 3120-C 6,3, ISO 1174, with ball retaining groove
- according to DIN 7422

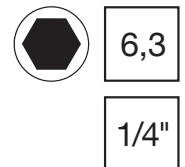

Code	Number	l/mm	Pieces	Weight/g	Code	Number	l/mm	Pieces	Weight/g
1455010022005	1455-IN 2,5	25	12	10	1455110062000	1455-IN 1/8	25	12	10
1455010032000	1455-IN 3	25	12	10	1455110082000	1455-IN 5/32	25	12	10
1455010042000	1455-IN 4	25	12	10	1455110092000	1455-IN 3/16	25	12	11
1455010052000	1455-IN 5	25	12	11	1455110112000	1455-IN 7/32	25	12	11
1455010062000	1455-IN 6	25	12	11	1455110132000	1455-IN 1/4	25	12	11
1455010072000	1455-IN 7	25	12	12	1455110172000	1455-IN 5/16	25	12	14
1455010082000	1455-IN 8	25	12	14					

3243-TX...

SCREWDRIVER SOCKET 1/4"

- for inside TORX® screws
- matt chrome-plated
- knurled
- with manganese-phosphated blade
- ELORA-Chrome-Vanadium 31CrV3 / 1.2208
- female square according to DIN 3120-C 6,3, ISO 1174, with ball retaining groove
- TORX® = reg. trademark of Acument Intellectual Properties, LLC. USA



6,3

1/4"



3243-TTX...

SCREWDRIVER SOCKET 1/4"

- for inside TORX® safety screws
- matt chrome-plated
- knurled
- with manganese-phosphated blade with bore hole
- ELORA-Chrome-Vanadium 31CrV3 / 1.2208
- female square according to DIN 3120-C 6,3, ISO 1174, with ball retaining groove
- TORX® = reg. trademark of Acument Intellectual Properties, LLC. USA



6,3

1/4"



Code	Number	★ mm	l/mm	Pieces ☞	Weight/g ⚖
3243000082000	3243-TX 8	2,31	28	6	7
3243000092000	3243-TX 9	2,50	28	6	7
3243000102000	3243-TX 10	2,74	28	6	8
3243000152000	3243-TX 15	3,27	28	6	8
3243000202000	3243-TX 20	3,86	28	6	8
3243000252000	3243-TX 25	4,43	28	6	8
3243000272000	3243-TX 27	4,99	28	6	9
3243000302000	3243-TX 30	5,52	28	6	9
3243000402000	3243-TX 40	6,65	28	6	10

Code	Number	★ mm	l/mm	Pieces ☞	Weight/g ⚖
3243010082000	3243-TTX 8	2,31	28	6	7
3243010092000	3243-TTX 9	2,50	28	6	7
3243010102000	3243-TTX 10	2,74	28	6	8
3243010152000	3243-TTX 15	3,27	28	6	8
3243010202000	3243-TTX 20	3,86	28	6	8
3243010252000	3243-TTX 25	4,43	28	6	8
3243010272000	3243-TTX 27	4,99	28	6	9
3243010302000	3243-TTX 30	5,52	28	6	9
3243010402000	3243-TTX 40	6,65	28	6	10

1455-KL, 1455-MKL

SOCKET RAIL 1/4"

1455-KL:

- 15 shiftable socket clips
- two holes allow permanent mounting
- chrome-plated, polished

1455-MKL:

- 11 shiftable socket clips
- strong magnet enables firm mounting
- black coated



6,3

1/4"

Code	Number	l/mm	Pieces ☞	Weight/g ⚖
0000914146000	1455-KL	414	1	67
0000914146001	1455-MKL	200	1	122

1455-SB

PLASTIC HOLDER 1/4"

- appropriate for sockets nominal size 6,3 (1/4") and operation tools with female square



6,3

1/4"

Code	Number	Pieces ☞	Weight/g ⚖
0000700147000	1455-SB	1	10

1450-3

SPINNER HANDLE 1/4"

- ▶ nonslip QUATROLIT®-2C-handle
- ▶ with suspension hole
- ▶ matt chrome-plated
- ▶ ELORA-Chrome-Vanadium 31CrV3 / 1.2208
- ▶ male square according to DIN 3120-A 6,3, ISO 1174, with ball locking device
- ▶ according to DIN 3122, ISO 3315



6,3

1/4"

Code	Number	l/mm	Pieces	Weight/g
1450000032000	1450-3	150	6	92

1450-4

SLIDING T-BAR 1/4"

- ▶ matt chrome-plated
- ▶ ELORA-Chrome-Vanadium 31CrV3 / 1.2208
- ▶ male square according to DIN 3120-A 6,3, ISO 1174, with ball locking device
- ▶ according to DIN 3122, ISO 3315



6,3

1/4"

Code	Number	l/mm	Pieces	Weight/g
1450000042000	1450-4	115	6	48

1450-7

FLEXIBLE HANDLE 1/4"

- ▶ matt chrome-plated
- ▶ ELORA-Chrome-Vanadium 31CrV3 / 1.2208
- ▶ male square according to DIN 3120-A 6,3, ISO 1174, with ball locking device
- ▶ according to DIN 3122, ISO 3315



6,3

1/4"

Code	Number	l/mm	Pieces	Weight/g
1450000072000	1450-7	150	6	96

1450-...

EXTENSION BAR 1/4"

- ▶ matt chrome-plated
- ▶ ELORA-Chrome-Vanadium 31CrV3 / 1.2208
- ▶ square drive according to DIN 3120, ISO 1174, with ball locking device resp. with ball retaining groove
- ▶ according to DIN 3123, ISO 3316



6,3

1/4"

Code	Number	l/mm	Pieces	Weight/g
1450000112000	1450-11	50	6	24
1450000052000	1450-5	100	6	42
1450000122000	1450-12	150	6	64

1450-6

FLEXIBLE EXTENSION BAR 1/4"

- ▶ matt chrome-plated
- ▶ ELORA-Chrome-Vanadium 31CrV3 / 1.2208
- ▶ square drive according to DIN 3120, ISO 1174, with ball locking device resp. with ball retaining groove



6,3

1/4"

Code	Number	l/mm	Pieces	Weight/g
1450000062000	1450-6	125	6	50

1450-8

UNIVERSAL JOINT 1/4"

- ▶ matt chrome-plated
- ▶ ELORA-Chrome-Vanadium 31CrV3 / 1.2208
- ▶ square drive according to DIN 3120, ISO 1174, with ball locking device resp. with ball retaining groove
- ▶ according to DIN 3123, ISO 3316



6,3

1/4"

Code	Number	l/mm	Pieces	Weight/g
1450000082000	1450-8	45	6	25

1450-../870-10

SOCKET CONVERTER 1/4"

- ▶ matt chrome-plated
- ▶ ELORA-Chrome-Vanadium 31CrV3 / 1.2208
- ▶ square drive according to DIN 3120, ISO 1174, with ball locking device resp. with ball retaining groove
- ▶ according to DIN 3123, ISO 3316

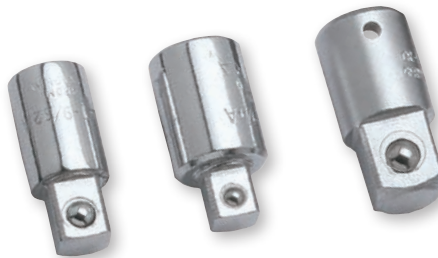

6,3

1/4"

Code	Number	□	○	l/mm	Pieces	Weight/g
1450000132000	1450-13	9/32"	1/4"	26	6	11
1450000142000	1450-14	1/4"	9/32"	26	6	15
1450000152000	1450-15	3/8"	1/4"	26	6	16
0870011002000	870-10	1/4"	3/8"	39	6	34

1450-16

SOCKET CONVERTER 1/4"

- ▶ matt chrome-plated
- ▶ ELORA-Chrome-Vanadium 31CrV3 / 1.2208
- ▶ female hexagon according to DIN 3126-D 6,3, with bit retaining spring
- ▶ female square according to DIN 3120-C 6,3, ISO 1174, with ball retaining groove



6,3

1/4"

Code	Number	l/mm	□	○	Pieces	Weight/g
1450000162000	1450-16	25	1/4"	1/4"	6	12

1430-...

SOCKET SET 1/4"

- MU=16 pcs., AU=14 pcs.
- in black metal storage case with OMS-hard foam insert
- square drive according to DIN 3120, ISO 1174
- operation tools according to DIN 3122, ISO 3315



6,3

1/4"



Code	Number	Ratchet	Sockets	Accessories	Pieces	Weight/g
1430504132000	1430-MU	Reversible Ratchet 1450-1D	Hexagon Sockets 1455-M 4, 4.5, 5, 5.5, 6, 7, 8, 9, 10, 11, 13 mm	Spinner Handle 1450-3 Sliding T-Bar 1450-4 Extension Bar 100 mm 1450-5 Universal Joint 1450-8	1	924
1430609232000	1430-AU	Reversible Ratchet 1450-1D	Hexagon Sockets 1455A-3/16, 7/32, 1/4, 9/32, 5/16, 11/32, 3/8, 7/16, 1/2 AF	Spinner Handle 1450-3 Sliding T-Bar 1450-4 Extension Bar 100 mm 1450-5 Universal Joint 1450-8	1	790

1430-TXU/TTXU

SOCKET SET 1/4"

- 14 pcs.
- suitable for inside TORX® screws resp. inside TORX® safety screws
- in black metal storage case with plastic insert
- square drive according to DIN 3120, ISO 1174
- operation tools according to DIN 3122, ISO 3315
- TORX® = reg. trademark of Acument Intellectual Properties, LLC. USA



6,3



1/4"

Code	Number	Ratchet	Sockets	Accessories	Pieces	Weight/g
1430505102000	1430-TXU	Reversible Ratchet 1450-1D	Screwdriver Sockets 3243-TX 8, 9, 10, 15, 20, 25, 27, 30, 40	Spinner Handle 1450-3 Sliding T-Bar 1450-4 Extension Bar 100 mm 1450-5 Universal Joint 1450-8	1	782
1430505202000	1430-TTXU	Reversible Ratchet 1450-1D	Screwdriver Sockets 3243-TTX 8, 9, 10, 15, 20, 25, 27, 30, 40	Spinner Handle 1450-3 Sliding T-Bar 1450-4 Extension Bar 100 mm 1450-5 Universal Joint 1450-8	1	775

1430-TXEU/TTXEU

SOCKET SET 1/4"

- 21 pcs.
- suitable for inside- and outside TORX® screws resp. inside TORX® safety screws
- in black metal storage case with OMS-hard foam insert
- square drive according to DIN 3120, ISO 1174
- operation tools according to DIN 3122, ISO 3315
- TORX® = reg. trademark of Acument Intellectual Properties, LLC. USA



6,3



1/4"



Code	Number	Ratchet	Sockets	Accessories	Pieces	Weight/g
1430505302000	1430-TXEU	Reversible Ratchet 1450-1D	Sockets 1455-TXE 4, 5, 6, 7, 8, 10, 11 Screwdriver Sockets 3243-TX 8, 9, 10, 15, 20, 25, 27, 30, 40	Spinner Handle 1450-3 Sliding T-Bar 1450-4 Extension Bar 100 mm 1450-5 Universal Joint 1450-8	1	780
1430505402000	1430-TTXEU	Reversible Ratchet 1450-1D	Sockets 1455-TXE 4, 5, 6, 7, 8, 10, 11 Screwdriver Sockets 3243-TTX 8, 9, 10, 15, 20, 25, 27, 30, 40	Spinner Handle 1450-3 Sliding T-Bar 1450-4 Extension Bar 100 mm 1450-5 Universal Joint 1450-8	1	843

1400-I...

SOCKET SET 1/4"

- MU=21 pcs., AU=20 pcs.
- in black metal storage case with OMS-hard foam insert
- square drive according to DIN 3120, ISO 1174
- operation tools according to DIN 3122, ISO 3315

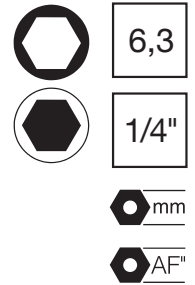

Code	Number	Ratchet	Sockets	Accessories	Pieces	Weight/g
1400514132000	1400-IMU	Reversible Ratchet 1450-1D	Sockets 1455-M 4, 4,5, 5, 5,5, 6,7, 8, 9, 10, 11, 13 mm Screwdriver Sockets 1455-IN 3, 4, 5, 6, 8 mm	Spinner Handle 1450-3 Sliding T-Bar 1450-4 Extension Bar 100 mm 1450-5 Universal Joint 1450-8	1	880
1400619232000	1400-IAU	Reversible Ratchet 1450-1D	Sockets 1455-A- 3/16, 7/32, 1/4, 9/32, 5/16, 11/32, 3/8, 7/16, 1/2 AF Screwdriver Sockets 1455-IN 1/8, 5/32, 3/16, 7/32, 1/4, 5/16 AF"	Spinner Handle 1450-3 Sliding T-Bar 1450-4 Extension Bar 100 mm 1450-5 Universal Joint 1450-8	1	872

714-6MU

SOCKET SET 1/4" AND 1/2"

- 25 pcs.
- in black metal storage case with plastic insert
- square drive according to DIN 3120, ISO 1174
- operation tools according to DIN 3122, ISO 3315

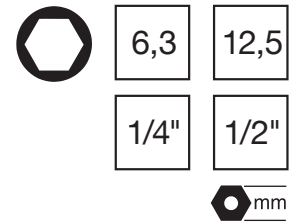

Code	Number	Ratchet	Sockets	Accessories	Pieces	Weight/g
0714562502000	714-6MU	1/4": Reversible Ratchet 1450-1D 1/2": Reversible Ratchet 770-L1D	Hexagon Sockets 1/4": 1455-M 5,5, 6, 7, 8, 9, 10, 11, 12, 13 mm 1/2": 771-LM 10, 13, 15, 17, 19, 22, 24, 27 mm	1/4": Spinner Handle 1450-3 Extension Bar 100 mm 1450-5 Universal Joint 1450-8 1/2": Extension Bar 125 mm 770-L5 Extension Bar 250 mm 770-L6 Universal Joint 770-L7"	1	3600

714-6MU OMS

SOCKET SET 1/4" AND 1/2", COMBINED

- 46 pcs.
- in black metal storage case with OMS-hard foam insert
- square drive according to DIN 3120, ISO 1174
- operation tools according to DIN 3122, ISO 3315

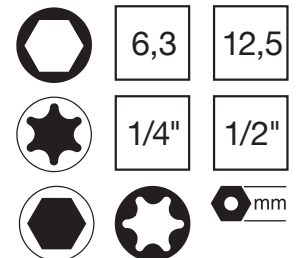

Code	Number	Ratchet	Sockets	Accessories	Pieces	Weight/g
0714562502046	714-6MU OMS	1/4": Reversible Ratchet 1450-1D 1/2": Reversible Ratchet 770-L1D	Sockets 1/4" 1455-M 5,5, 6, 7, 8, 9, 10, 11, 12, 13 mm 1455-TXE 4, 5, 6, 7, 8, 10, 11 Hexagon Sockets 1/2" 771-LM 10, 13, 15, 17, 19, 22, 24, 27 mm Screwdriver Sockets 1/4" 3243-TX 8, 9, 10, 15, 20, 25, 27, 30, 40 1455-IN 3, 4, 5, 6, 8 mm	1/4": Spinner Handle 1450-3 Extension Bar 100 mm 1450-5 Universal Joint 1450-8 1/2": Extension Bar 125 mm 770-L5 Extension Bar 250 mm 770-L6 Universal Joint 770-L7	1	3600

1440-...

SOCKET SET 1/4"

- MU=30 pcs., AU=31 pcs.
- in black metal storage case with OMS-hard foam insert
- square drive according to DIN 3120, ISO 1174
- operation tools according to DIN 3122, ISO 3315

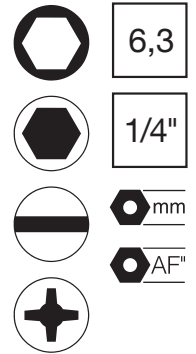

03

Code	Number	Ratchet	Sockets	Accessories	Pieces	Weight/g
1440504142000	1440-MU	Reversible Ratchet 1450-1D	Sockets 1455-M 4, 4,5, 5, 5,5, 6, 7, 8, 9, 10, 11, 12, 13, 14 mm Screwdriver Sockets 1455-IN 3, 4, 5, 6, 8 mm 1455-IS 4, 5,5, 6,5 mm 1455-PH 1, 2, 3	Spinner Handle 1450-3 Sliding T-Bar 1450-4 Extension Bar 50 mm 1450-11 Extension Bar 100 mm 1450-5 Extension Bar 150 mm 1450-12 Universal Joint 1450-8	1	1160
1440608242000	1440-AU	Reversible Ratchet 1450-1D	Sockets 1455A- 5/32, 3/16, 7/32, 1/4, 9/32, 5/16, 11/32, 3/8, 7/16, 1/2, 9/16 AF Screwdriver Sockets 1455-IN 1/8, 5/32, 3/16, 7/32, 1/4, 5/16 AF 1455-IS 4, 5,5, 6,5 mm 1455-PH 1, 2, 3	Spinner Handle 1450-3 Sliding T-Bar 1450-4 Extension Bar 50 mm 1450-11 Extension Bar 100 mm 1450-5 Extension Bar 150 mm 1450-12 Universal Joint 1450-8	1	1145

1400-TXE

SOCKET SET 1/4"

- 16-pcs.
- suitable for inside- and outside TORX® screws
- in black metal storage case with OMS-hard foam insert
- female square according to DIN 3120-C, 6,3, ISO 1174, with ball retaining groove
- TORX® = reg. trademark of Acument Intellectual Properties, LLC. USA



Code	Number	Contents	Pieces	Weight/g
1400510529000	1400-TXE	Sockets 1/4" for outside TORX® screws 1455-TXE 4, 5, 6, 7, 8, 10, 11 mm Screwdriver Sockets 1/4" for inside TORX® screws 3243-TTX 8, 9, 10, 15, 20, 25, 27, 30, 40 mm	1	1500

You will find combined socket sets 1/4" and 1/2" on page no. 143



870-1D
REVERSIBLE RATCHET 3/8", FINE TOOTH

- rugged ratchet with small, slim head
- forged gear wheel with safety locking and quick release button
- smallest possible swivel angle 5°
- nonslip QUATROLIT®-2C-handle
- with suspension hole
- matt chrome-plated
- ELORA-Chrome-Vanadium 31CrV3 / 1.2208
- male square according to DIN 3120-A 10, ISO 1174, with ball locking device
- according to DIN 3122, ISO 3315



10

3/8"

Code	Number	l/mm ┌┐	Pieces ☞	Weight/g ⚖
0870001012000	870-1D	200	1	240
0870010132000	870-E1D	Repair Kit	1	60

03

870-1UN
REVERSIBLE RATCHET 3/8", FINE TOOTH

- with small, round head
- forged, fine teethed wheel with grippy metal switching disk
- smallest possible swivel angle 5°
- nonslip QUATROLIT®-2C-handle
- with suspension hole
- matt chrome-plated
- ELORA-Chrome-Vanadium 31CrV3 / 1.2208
- male square according to DIN 3120-A 10, ISO 1174, with ball locking device
- according to DIN 3122, ISO 3315



10

3/8"

Code	Number	l/mm ┌┐	Pieces ☞	Weight/g ⚖
0870001012900	870-1UN	195	1	221
0870010182000	870-E1UN	Repair Kit	1	50

870-1ZI
PUSH THROUGH RATCHET 3/8"

- extremely rugged ratchet with round head
- forged gear wheel with push through square coupler
- smallest possible swivel angle 15°
- plastic handle
- matt chrome-plated
- ELORA-Chrome-Vanadium 31 CrV 3 / 1.2208
- square according to DIN 3120-A 10, ISO 1174, with ball locking device
- according to DIN 3122, ISO 3315

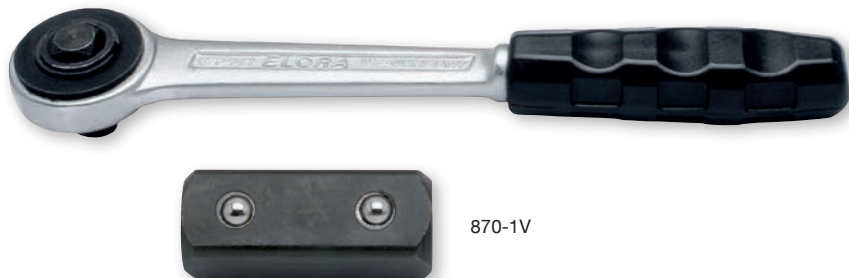

10

3/8"

870-1V

Code	Number	l/mm ┌┐	Pieces ☞	Weight/g ⚖
0870010112000	870-1ZI	200	1	239
0870010122000	870-1V	25	12	35
0870010152000	870-E1ZI	Repair Kit	1	70

870-M..., 870-A..., 870-W...

SOCKET 3/8", BI-HEXAGON

- hot forged
- chrome-plated, polished
- knurled
- ELORA-Chrome-Vanadium 31CrV3 / 1.2208
- female square according to DIN 3120-C 10, ISO 1174, with ball retaining groove
- according to DIN 3124, ISO 2725-1



10

3/8"

mm

AF"

Code	Number	l/mm	Pieces	Weight/g
0870000062000	870-M 6	25	6	24
0870000072000	870-M 7	25	6	24
0870000082000	870-M 8	25	6	24
0870000092000	870-M 9	25	6	26
0870000102000	870-M 10	25	6	26
0870000112000	870-M 11	25	6	26
0870000122000	870-M 12	25	6	26
0870000132000	870-M 13	25	6	28
0870000142000	870-M 14	25	6	28
0870000152000	870-M 15	25	6	30
0870000162000	870-M 16	25	6	30
0870000172000	870-M 17	26	6	38
0870000182000	870-M 18	27	6	38
0870000192000	870-M 19	28	6	38
0870000202000	870-M 20	28	6	46
0870000212000	870-M 21	28,5	6	52
0870000222000	870-M 22	28,5	6	60
0870000242000	870-M 24	28,5	6	68

Code	Number	l/mm	Pieces	Weight/g
0870100232000	870-A 1/2	25	6	26
0870100242000	870-A 9/16	25	6	26
0870100252000	870-A 19/32	25	6	30
0870100272000	870-A 11/16	26	6	40
0870100282000	870-A 3/4	28	6	46
0870100292000	870-A 25/32	28	6	46
0870100302000	870-A 13/16	29	6	48
0870100312000	870-A 7/8	29	6	52

WW

Code	Number	l/mm	Pieces	Weight/g
0870200092000	870-W 3/16	25	6	26
0870200132000	870-W 1/4	25	6	26
0870200172000	870-W 5/16	25	6	30
0870200192000	870-W 3/8	27	6	34
0870200232000	870-W 1/2	28,5	6	60

871-M..., 871-A...

SOCKET 3/8", HEXAGON

- hot forged
- chrome-plated, polished
- knurled
- ELORA-Chrome-Vanadium 31CrV3 / 1.2208
- female square according to DIN 3120-C 10, ISO 1174, with ball retaining groove
- according to DIN 3124, ISO 2725-1



10

3/8"

mm

AF"

Code	Number	l/mm	Pieces	Weight/g
0871000062000	871-M 6	25	6	24
0871000072000	871-M 7	25	6	24
0871000082000	871-M 8	25	6	24
0871000092000	871-M 9	25	6	26
0871000102000	871-M 10	25	6	26
0871000112000	871-M 11	25	6	26
0871000122000	871-M 12	25	6	26
0871000132000	871-M 13	25	6	28
0871000142000	871-M 14	25	6	28
0871000152000	871-M 15	25	6	30
0871000162000	871-M 16	25	6	30
0871000172000	871-M 17	26	6	38
0871000182000	871-M 18	27	6	38
0871000192000	871-M 19	28	6	38
0871000202000	871-M 20	28	6	46
0871000212000	871-M 21	28,5	6	52
0871000222000	871-M 22	28,5	6	60
0871000242000	871-M 24	28,5	6	68

Code	Number	l/mm	Pieces	Weight/g
0871100132000	871-A1/4	25	6	24
0871100172000	871-A5/16	25	6	24

870-T...

SOCKET 3/8", EXTRA DEEP, BI-HEXAGON

- especially suitable for deep-set female screws on long threaded bolts
- hot forged
- chrome-plated, polished
- knurled
- ELORA-Chrome-Vanadium 31CrV3 / 1.2208
- female square according to DIN 3120-C 10, ISO 1174, with ball retaining groove
- according to DIN 3124, ISO 2725-1



10

3/8"



870-TXE...

SOCKET 3/8"

- for outside TORX® screws
- chrome-plated, polished
- knurled
- ELORA-Chrome-Vanadium 31CrV3 / 1.2208
- female square according to DIN 3120-C 10, ISO 1174, ball retaining groove
- TORX® = reg. trademark of Acument Intellectual Properties, LLC. USA



10

3/8"



Code	Number	l/mm ┌───┐	Pieces 📦	Weight/g ⚖️
0870003102000	870-T 10	65	6	45
0870003112000	870-T 11	65	6	50
0870003122000	870-T 12	65	6	55
0870003132000	870-T 13	65	6	60
0870003142000	870-T 14	65	6	65
0870003152000	870-T 15	65	6	70
0870003162000	870-T 16	70	6	80
0870003172000	870-T 17	70	6	95
0870003182000	870-T 18	70	6	105
0870003192000	870-T 19	70	6	108
0870003202000	870-T 20	70	6	120
0870003212000	870-T 21	70	6	125
0870003222000	870-T 22	70	6	128

Code	Number	Star mm	l/mm ┌───┐	Pieces 📦	Weight/g ⚖️
0870020052000	870-TXE 5	4,75	31	6	36
0870020062000	870-TXE 6	5,74	31	6	37
0870020072000	870-TXE 7	6,22	31	6	37
0870020082000	870-TXE 8	7,52	31	6	37
0870020102000	870-TXE 10	9,42	31	6	40
0870020112000	870-TXE 11	9,98	31	6	40
0870020122000	870-TXE 12	11,17	31	6	40
0870020142100	870-TXE 14	12,85	31	6	44

03

You will find the matching spark plug sockets on page no. 439, 440



870-11

SCREWDRIVER SOCKET 3/8"

- for plain slotted screws
- chrome-plated, polished
- ELORA-Chrome-Vanadium 31CrV3 / 1.2208
- female square according to DIN 3120-C 10, ISO 1174, with ball retaining groove



10

3/8"



3500-IS...

SCREWDRIVER SOCKET 3/8"

- for plain slotted screws
- chrome-plated, polished
- knurled
- holder made of ELORA-Chrome-Vanadium 31CrV3 / 1.2208
- Female square according to DIN 3120-C 10, ISO 1174, with ball retaining groove
- blade made of ELORA-Vanadium special steel, gunmetal finished
- blade according to DIN ISO 2380-1 Form B



10

3/8"



03

Code	Number	Blade Size mm	l/mm	Pieces	Weight/g
0870011102000	870-11	16x3,0	39	6	52

Code	Number	Blade Size mm	l/mm	Pieces	Weight/g
3500000082000	3500-IS 0,8	0,8x4,0	52	6	50
3500000102000	3500-IS 1,0	1,0x5,5	52	6	50
3500000122000	3500-IS 1,2	1,2x8,0	52	6	52

3520-PH...

SCREWDRIVER SOCKET 3/8"

- for cross slotted screws
- chrome-plated, polished
- knurled
- holder made of ELORA-Chrome-Vanadium 31CrV3 / 1.2208
- female square according to DIN 3120-C 10, ISO 1174, with ball retaining groove
- blade made of ELORA-Vanadium special steel, gunmetal finished
- blade according to DIN ISO 8764-1 PH



10

3/8"



Code	Number	l/mm	Pieces	Weight/g
3520000032000	3520-PH 3	48	6	52
3520000042000	3520-PH 4	48	6	52

3510-IN...

SCREWDRIVER SOCKET 3/8"

- for inside hexagon screws
- chrome-plated, polished
- knurled
- holder made of ELORA-Chrome-Vanadium 31CrV3 / 1.2208
- female square according to DIN 3120-C 10, ISO 1174, with ball retaining groove
- blade made of ELORA-Vanadium special steel, gunmetal finished
- according to DIN 7422



10

3/8"



Code	Number	DIN 912	l/mm	Pieces	Weight/g
3510000032000	3510-IN 3	M4	44	6	50
3510000042000	3510-IN 4	M5	44	6	50
3510000052000	3510-IN 5	M6	44	6	52
3510000062000	3510-IN 6	M8	44	6	52
3510000072000	3510-IN 7		44	6	54
3510000082000	3510-IN 8	M10	44	6	54
3510000092000	3510-IN 9		44	6	58
3510000102000	3510-IN 10	M12	44	6	58
3510000122000	3510-IN 12	M14	44	6	58

Code	Number	l/mm	Pieces	Weight/g
3510100062000	3510-IN 1/8	44	6	48
3510100082000	3510-IN 5/32	44	6	48
3510100092000	3510-IN 3/16	44	6	48
3510100112000	3510-IN 7/32	44	6	48
3510100132000	3510-IN 1/4	44	6	52
3510100172000	3510-IN 5/16	44	6	52
3510100192000	3510-IN 3/8	44	6	58

3510-INL...

SCREWDRIVER SOCKET 3/8", LONG

- for inside hexagon screws
- chrome-plated, polished
- knurled
- holder made of ELORA-Chrome-Vanadium 31CrV3 / 1.2208
- female square according to DIN 3120-C 10, ISO 1174, with ball retaining groove
- blade made of ELORA-Vanadium special steel, gunmetal finished
- according to DIN 7422

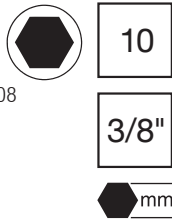

Code	Number	mm	l/mm	Pieces	Weight/g
3510010042100	3510-INL 4x100	M5	100	6	70
3510010052100	3510-INL 5x100	M6	100	6	72
3510010052180	3510-INL 5x180	M6	180	6	108
3510010062100	3510-INL 6x100	M6	100	6	77
3510010062220	3510-INL 6x220	M6	220	6	122
3510010082100	3510-INL 8x100	M10	100	6	74
3510010102130	3510-INL 10x130	M12	130	6	116

3244-TXL-45

SCREWDRIVER SOCKET 3/8", LONG

- for inside TORX® screws
- chrome-plated, polished
- knurled
- holder made of ELORA-Chrome-Vanadium 31CrV3 / 1.2208
- female square according to DIN 3120-C 10, ISO 1174, with ball retaining groove
- blade made of ELORA-Vanadium special steel, gunmetal finished
- TORX® = reg. trademark of Acument Intellectual Properties, LLC. USA

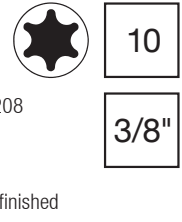

Code	Number	mm	l/mm	Pieces	Weight/g
3244020451100	3244-TXL 45	7,82	100	6	87

3244-TX...

SCREWDRIVER SOCKET 3/8"

- for inside TORX® screws
- chrome-plated, polished
- knurled
- holder made of ELORA-Chrome-Vanadium 31CrV3 / 1.2208
- female square according to DIN 3120-C 10, ISO 1174, with ball retaining groove
- blade made of ELORA-Vanadium special steel, gunmetal finished
- TORX® = reg. trademark of Acument Intellectual Properties, LLC. USA

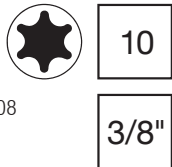

Code	Number	mm	l/mm	Pieces	Weight/g
3244000092000	3244-TX 9	2,50	46	6	50
3244000102000	3244-TX 10	2,74	46	6	50
3244000152000	3244-TX 15	3,27	46	6	52
3244000202000	3244-TX 20	3,86	46	6	54
3244000252000	3244-TX 25	4,43	46	6	54
3244000272000	3244-TX 27	4,99	46	6	54
3244000302000	3244-TX 30	5,52	46	6	60
3244000402000	3244-TX 40	6,65	46	6	62
3244000452000	3244-TX 45	7,82	46	6	65
3244000502000	3244-TX 50	8,83	46	6	70

3244-TTX...

SCREWDRIVER SOCKET 3/8"

- for Inside-TORX® safety screws
- with bore hole in tip
- chrome-plated, polished
- knurled
- holder made of ELORA-Chrome-Vanadium 31CrV3 / 1.2208
- female square according to DIN 3120-C 10, ISO 1174, with ball retaining groove
- blade made of ELORA-Vanadium special steel, gunmetal finished
- TORX® = reg. trademark of Acument Intellectual Properties, LLC. USA

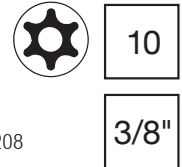

Code	Number	mm	l/mm	Pieces	Weight/g
3244010092000	3244-TTX 9	2,50	46	6	50
3244010102000	3244-TTX 10	2,74	46	6	50
3244010152000	3244-TTX 15	3,27	46	6	52
3244010202000	3244-TTX 20	3,86	46	6	54
3244010252000	3244-TTX 25	4,43	46	6	54
3244010272000	3244-TTX 27	4,99	46	6	54
3244010302000	3244-TTX 30	5,52	46	6	60
3244010402000	3244-TTX 40	6,65	46	6	62
3244010452000	3244-TTX 45	7,82	46	6	65
3244010502000	3244-TTX 50	8,83	46	6	70

3530-XZN...

SCREWDRIVER SOCKET 3/8"

- for inside multi-point B & S and XZN screws
- chrome-plated, polished
- knurled
- holder made of ELORA-Chrome-Vanadium 31CrV3 / 1.2208
- female square according to DIN 3120-C 10, ISO 1174, with ball retaining groove
- blade made of ELORA-Vanadium special steel, gunmetal finished
- Blade according to DIN 2325



10

3/8"



3530-XZNL...

SCREWDRIVER SOCKET 3/8", EXTRA LONG

- for inside multi-point screws
- suitable for inside B & S and XZN screws
- chrome-plated, polished
- knurled
- holder made of ELORA-Chrome-Vanadium 31CrV3 / 1.2208
- female square according to DIN 3120-C 10, ISO 1174, with ball retaining groove
- blade made of ELORA-Vanadium special steel, gunmetal finished
- blade according to DIN 2325



10

3/8"



Code	Number	mm	l/mm	Pieces	Weight/g
3530000052000	3530-XZN 5	M5	44	6	48
3530000062000	3530-XZN 6	M6	44	6	50
3530000082000	3530-XZN 8	M8	45	6	50
3530000102000	3530-XZN 10	M10	45	6	58

Code	Number	mm	l/mm	Pieces	Weight/g
3530010102093	3530-XZNL 10x93	M10	93	6	92

870-M SB

PLASTIC HOLDER 3/8"

- appropriate for sockets nominal size 10 (3/8") and operation tools with female square



10

3/8"

Code	Number	Pieces	Weight/g
0000700387000	870-M SB	1	10

870-KL, 870-MKL

SOCKET RAIL 3/8"

- **870-KL:**
- 15 shiftable socket clips
- two holes allow permanent mounting
- chrome-plated, polished

10

3/8"

- **870-MKL:**
- 11 shiftable socket clips
- strong magnet enables firm mounting
- black coated



Code	Number	l/mm	Pieces	Weight/g
0000938146000	870-KL	414	1	72
0000938146001	870-MKL	300	1	172

03



You will find the matching BIG SPENDER on page no. 171, 172



870-7

FLEXIBLE HANDLE 3/8"

- matt chrome-plated
- plastic handle
- ELORA-Chrome-Vanadium 31CrV3 / 1.2208
- male square according to DIN 3120-A 10, ISO 1174, with ball locking device
- according to DIN 3122, ISO 3315

10

3/8"



Code	Number	l/mm	Pieces	Weight/g
0870010702000	870-7	250	6	240

870-12

SPINNER-HANDLE 3/8"

- nonslip QUATROLIT®-2C-handle
- with suspension hole
- matt chrome-plated
- ELORA-Chrome-Vanadium 31CrV3 / 1.2208
- male square according to DIN 3120-A 10, ISO 1174, with ball locking device
- according to DIN 3122, ISO 3315

10

3/8"



Code	Number	l/mm	Pieces	Weight/g
0870011202000	870-12	180	6	170

870-8

SLIDING T-BAR 3/8"

- matt chrome-plated
- ELORA-Chrome-Vanadium 31CrV3 / 1.2208
- male square according to DIN 3120-A 10, ISO 1174, with ball locking device
- according to DIN 3122, ISO 3315

10

3/8"



Code	Number	l/mm	Pieces	Weight/g
0870010802000	870-8	200	6	155

870-2

SPEED BRACE 3/8"

- matt chrome-plated
- plastic handle
- ELORA-Chrome-Vanadium 31CrV3 / 1.2208
- male square according to DIN 3120-A 10, ISO 1174, with ball locking device
- according to DIN 3122, ISO 3315

10

3/8"



Code	Number	l/mm	Pieces	Weight/g
0870010202000	870-2	345	6	345

870-...

EXTENSION BAR 3/8"

- ▶ matt chrome-plated, head polished
- ▶ ELORA-Chrome-Vanadium 31CrV3 / 1.2208
- ▶ square drive according to DIN 3120, ISO 1174, with ball retaining groove resp. with ball locking device
- ▶ according to DIN 3123, ISO 3316

10

3/8"



Code	Number	l/mm	Pieces	Weight/g
0870010252000	870-25	35	6	42
0870010302000	870-3	75	6	68
0870010352000	870-35	125	6	104
0870010402000	870-4	150	6	124
0870010502000	870-5	200	6	170
0870010552000	870-55	250	6	200
0870010602000	870-6	300	6	240
0870010662000	870-66	500	6	390

870-V...

EXTENSION BAR 3/8", SWIVELLING

- ▶ matt chrome-plated, head polished
- ▶ with special square for a swivel angle of 8° to each side
- ▶ especially suitable for screw connections within confined spaces
- ▶ ELORA-Chrome-Vanadium 31CrV3 / 1.2208
- ▶ square drive according to DIN 3120, ISO 1174, with ball retaining groove resp. with ball locking device
- ▶ according to DIN 3123, ISO 3316

10

3/8"



Code	Number	l/mm	Pieces	Weight/g
0870010302100	870-3V	75	6	68
0870010352100	870-35V	125	6	104
0870010402500	870-4V	150	6	124
0870010552500	870-55V	250	6	200

870-9

UNIVERSAL JOINT 3/8"

- ▶ chrome-plated, polished
- ▶ ELORA-Chrome-Vanadium 31CrV3 / 1.2208
- ▶ square drive according to DIN 3120, ISO 1174, with ball retaining groove resp. with ball locking device
- ▶ according to DIN 3123, ISO 3316

10

3/8"



Code	Number	l/mm	Pieces	Weight/g
0870010902000	870-9	55	6	68

870-10/770-L.../1450-15

SOCKET CONVERTER

- ▶ matt chrome-plated
- ▶ ELORA-Chrome-Vanadium 31CrV3 / 1.2208
- ▶ square drive according to DIN 3120, ISO 1174, with ball locking device resp. with ball retaining groove
- ▶ according to DIN 3123, ISO 3316

10

3/8"



Code	Number	□	○	l/mm	Pieces	Weight/g
0870011002000	870-10	1/4"	3/8"	32	6	34
0770013002000	770-L13	3/8"	1/2"	40	6	65
0770014002000	770-L14	1/2"	3/8"	36	6	60
1450000152000	1450-15	3/8"	1/4"	26	6	16

870-J.../871-J...

SOCKET SET 3/8"

- 18 pcs.
- in black metal storage case with plastic insert
- square drive according to DIN 3120, ISO 1174, with ball retaining groove
- operation tools according to DIN 3122, ISO 3315

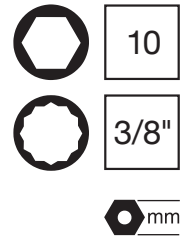

03

Code	Number	Ratchet	Sockets	Accessories	Pieces	Weight/g
0870500502000	870-JMU	Reversible Ratchet 870-1D	Bi-Hexagon Sockets 870-M 6, 7, 8, 9, 10, 11, 13, 14, 15, 16, 17, 18, 19, 21, 22 mm	Extension Bar 150 mm 870-4 Sliding T-Bar 870-8	1	1532
0871501802000	871-JMU	Reversible Ratchet 870-1D	Hexagon Sockets 871-M 6, 7, 8, 9, 10, 11, 13, 14, 15, 16, 17, 18, 19, 21, 22 mm	Extension Bar 150 mm 870-4 Sliding T-Bar 870-8	1	1500

870-JSU/871-JSU

SOCKET SET 3/8"

- 20 pcs.
- in black metal storage case with OMS-hard foam insert
- square drive according to DIN 3120, ISO 1174, with ball retaining groove
- operation tools according to DIN 3122, ISO 3315

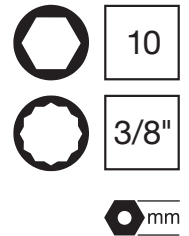

Code	Number	Ratchet	Sockets	Accessories	Pieces	Weight/g
0870500702000	870-JSU	Reversible Ratchet 870-1D	Bi-Hexagon Sockets 870-M 6, 7, 8, 9, 10, 11, 13, 14, 15, 16, 17, 18, 19, 21, 22 mm	Extension Bar 75 mm 870-3 Extension Bar 150 mm 870-4 Sliding T-Bar 870-8 Universal Joint 870-9	1	1993
0871502002000	871-JSU	Reversible Ratchet 870-1D	Hexagon Sockets 871-M 6, 7, 8, 9, 10, 11, 13, 14, 15, 16, 17, 18, 19, 21, 22 mm	Extension Bar 75 mm 870-3 Extension Bar 150 mm 870-4 Sliding T-Bar 870-8 Universal Joint 870-9	1	1900

You will find the matching OMS-34/21 module on page no.47



870-.../871-MU

SOCKET SET 3/8"

- 27 pcs.
- in black metal storage case with plastic insert
- square drive according to DIN 3120, ISO 1174, with ball retaining groove
- operation tools according to DIN 3122, ISO 3315

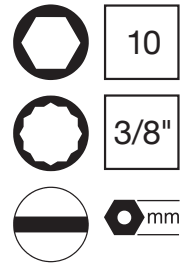
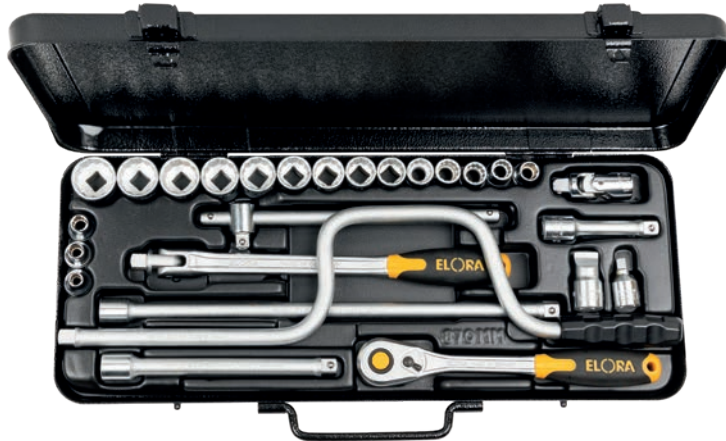

03

Code	Number	Ratchet	Sockets	Accessories	Pieces	Weight/g
0870500102000	870-MU	Reversible Ratchet 870-1D	Bi-Hexagon Sockets 870-M 6, 7, 8, 9, 10, 11, 12, 13, 14, 15, 16, 17, 18, 19, 20, 21, 22 mm Screwdriver Socket 870-11, IS 16x3,0 mm	Speed Brace 870-2 Extension Bar 75 mm 870-3 Extension Bar 150 mm 870-4 Extension Bar 300 mm 870-6 Flexible Handle 870-7 Sliding T-Bar 870-8 Universal Joint 870-9 Socket Converter 870-10, Male 1/4, Female 3/8	1	3520
0871502202000	871-MU	Reversible Ratchet 870-1D	Hexagon Sockets 871-M 6, 7, 8, 9, 10, 11, 12, 13, 14, 15, 16, 17, 18, 19, 20, 21, 22 mm Screwdriver Socket 870-11, IS 16x3,0 mm	Speed Brace 870-2 Extension Bar 75 mm 870-3 Extension Bar 150 mm 870-4 Extension Bar 300 mm 870-6 Flexible Handle 870-7 Sliding T-Bar 870-8 Universal Joint 870-9 Socket Converter 870-10, Male 1/4, Female 3/8	1	3900

870-IN...

SOCKET SET 3/8"

- 8 pcs.
- in black metal storage case with plastic insert
- square drive according to DIN 3120, ISO 1174, with ball retaining groove
- operation tools according to DIN 3122, ISO 3315



10

3/8"

mm

AF"

Code	Number	Ratchet	Sockets	Accessories	Pieces	Weight/g
0870510002000	870-INMU	Reversible Ratchet 870-1D	Screwdriver Sockets for inside Hexagon screws 3510-IN 3, 4, 5, 6, 8, 10 mm	Extension Bar 125 mm 870-35	1	1181
0870610002000	870-INAU	Reversible Ratchet 870-1D	Screwdriver Sockets for inside Hexagon screws 3510-IN 1/8, 5/32, 3/16, 7/32, 1/4, 5/16 AF	Extension Bar 125 mm 870-35	1	1168

870-TXU/TTXU

SOCKET SET 3/8"

- 12 pcs.
- suitable for inside TORX® screws resp. inside TORX® safety screws
- in black metal storage case with plastic insert
- square drive according to DIN 3120, ISO 1174, with ball retaining groove
- operation tools according to DIN 3122, ISO 3315
- TORX® = reg. trademark of Acument Intellectual Properties, LLC. USA



10



3/8"

Code	Number	Ratchet	Sockets	Accessories	Pieces	Weight/g
0870520102100	870-TXU	Reversible Ratchet 870-1D	Screwdriver Sockets for TORX®-screws 3244-TX 9, 10, 15, 20, 25, 27, 30, 40, 45, 50 mm	Extension Bar 125 mm 870-35	1	1378
0870521102000	870-TTXU	Reversible Ratchet 870-1D	Screwdriver Sockets for TORX®-screws 3244-TTX 9, 10, 15, 20, 25, 27, 30, 40, 45, 50 mm	Extension Bar 125 mm 870-35	1	1354

877-TXE

SOCKET SET 3/8"

- 13 pcs.
- suitable for outside TORX® screws
- in black metal storage case with plastic insert
- square drive according to DIN 3120, ISO 1174, with ball retaining groove
- TORX® = reg. trademark of Acument Intellectual Properties, LLC. USA



10

3/8"

12,5

1/2"

Code	Number	Sockets	Accessories	Pieces	Weight/g
0877500102000	877-TXE	Sockets 3/8" for outside TORX®-screws 870-TXE 5, 6, 7, 8, 10, 11, 12, 14 mm Sockets 1/2" for outside TORX®-screws 770-LTXE 16, 18, 20, 24 mm	Socket Converter 770-L13, Male 3/8, Female 1/2	1	1245

770-L1D
REVERSIBLE RATCHET 1/2"

- rugged ratchet with small, slim head
- forged gear wheel with male and female square
- smallest possible swivel angle 11,25°
- nonslip QUATROLIT®-2C-handle
- with suspension hole
- matt chrome-plated
- ELORA-Chrome-Vanadium 31CrV3 / 1.2208
- male square according to DIN 3120-A 12,5, ISO 1174, with ball locking device
- according to DIN 3122, ISO 3315



12,5

1/2"

Code	Number	l/mm	Pieces	Weight/g
0770000902000	770-L1D	270	1	530
0770000912001	770-LE1D	Repair Kit	1	120

03

770-L1F
REVERSIBLE RATCHET 1/2"

- rugged ratchet with small, slim head
- forged gear wheel with safety locking and quick release button
- smallest possible swivel angle 11,25°
- nonslip QUATROLIT®-2C-handle
- with suspension hole
- matt chrome-plated
- ELORA-Chrome-Vanadium 31CrV3 / 1.2208
- male square according to DIN 3120-A 12,5, ISO 1174, with ball locking device
- according to DIN 3122, ISO 3315



12,5

1/2"

Code	Number	l/mm	Pieces	Weight/g
0770000922000	770-L1F	270	1	483
0770000922003	770-LE1F	Repair Kit	1	120

770-L1K
REVERSIBLE RATCHET 1/2", FINE TOOTH

- with small, slim head
- forged gear wheel with safety locking and quick release button
- smallest possible swivel angle 5°
- nonslip QUATROLIT®-2C-handle
- with suspension hole
- matt chrome-plated
- ELORA-Chrome-Vanadium 31CrV3 / 1.2208
- male square according to DIN 3120-A 12,5, ISO 1174, with ball locking device
- according to DIN 3122, ISO 3315



12,5

1/2"

Code	Number	l/mm	Pieces	Weight/g
0770000802000	770-L1K	270	1	532
0770000852000	770-LE1K	Repair Kit	1	120

770-L1UN

REVERSIBLE RATCHET 1/2", FINE TOOTH

- with small, slim head
- forged, fine toothed wheel with grippy metal switching disk
- smallest possible swivel angle 5°
- nonslip QUATROLIT®-2C-handle
- with suspension hole
- matt chrome-plated
- ELORA-Chrome-Vanadium 31CrV3 / 1.2208
- male square according to DIN 3120-A 12,5, ISO 1174, with ball locking device
- according to DIN 3122, ISO 3315



12,5

1/2"

Code	Number	l/mm	Pieces	Weight/g
0770001012900	770-L1UN	260	1	508
0770001132000	770-LE1UN	Repair Kit	1	115

770-L115U

REVERSIBLE RATCHET 1/2"

- extra long design with slim head
- forged gear wheel with male and female square
- smallest possible swivel angle 11,25°
- nonslip QUATROLIT®-2C-handle
- with suspension hole
- matt chrome-plated
- ELORA-Chrome-Vanadium 31 CrV 3 / 1.2208
- male square according to DIN 3120-A 12,5, ISO 1174, with ball locking device



12,5

1/2"

Code	Number	l/mm	Pieces	Weight/g
0770001022000	770-L115U	375	1	656
0770000912001	770-LE1D	Repair Kit	1	120

770-L115F

REVERSIBLE RATCHET 1/2"

- extra long design with slim head
- forged gear wheel with safety locking and quick release button
- smallest possible swivel angle 11,25°
- nonslip QUATROLIT®-2C-handle
- with suspension hole
- matt chrome-plated
- ELORA-Chrome-Vanadium 31 CrV 3 / 1.2208
- male square according to DIN 3120-A 12,5, ISO 1174, with ball locking device



12,5

1/2"

Code	Number	l/mm	Pieces	Weight/g
0770001022100	770-L115F	375	1	662
0770000922003	770-LE1F	Repair Kit	1	120

770-L1G

REVERSIBLE RATCHET WITH HINGE 1/2"

- 180° swivelling
- forged gear wheel with male and female square
- smallest possible swivel angle 11,25°
- nonslip QUATROLIT®-2C-handle
- matt chrome-plated
- ELORA-Chrome-Vanadium 31CrV3 / 1.2208
- male square according to DIN 3120-A 12,5, ISO 1174, with ball locking device

12,5

1/2"



Code	Number	l/mm	Pieces	Weight/g
0770001032000	770-L1G	305	1	709
0770000912001	770-LE1D	Repair Kit	1	120

03

770-L1GF

REVERSIBLE RATCHET WITH HINGE 1/2"

- 180° swivelling
- forged gear wheel with safety locking and quick release button
- smallest possible swivel angle 11,25°
- nonslip QUATROLIT®-2C-handle
- matt chrome-plated
- ELORA-Chrome-Vanadium 31CrV3 / 1.2208
- male square according to DIN 3120-A 12,5, ISO 1174, with ball locking device

12,5

1/2"



Code	Number	l/mm	Pieces	Weight/g
0770001032100	770-L1GF	305	1	708
0770000922003	770-LE1F	Repair Kit	1	120

770-L115G

REVERSIBLE RATCHET WITH HINGE 1/2"

- extra long version
- 180° swivelling
- forged gear wheel with male and female square
- smallest possible swivel angle 11,25°
- nonslip QUATROLIT®-2C-handle
- with suspension hole
- matt chrome-plated
- ELORA-Chrome-Vanadium 31CrV3 / 1.2208
- male square according to DIN 3120-A 12,5, ISO 1174, with ball locking device

12,5

1/2"



Code	Number	l/mm	Pieces	Weight/g
0770001042000	770-L115G	430	1	879
0770000912001	770-LE1D	Repair Kit	1	135

770-L115GF

REVERSIBLE RATCHET WITH HINGE 1/2"

- extra long version
- 180° swivelling
- forged gear wheel with safety locking and quick release button
- smallest possible swivel angle 11,25°
- nonslip QUATROLIT®-2C-handle
- with suspension hole
- matt chrome-plated
- ELORA-Chrome-Vanadium 31CrV3 / 1.2208
- male square according to DIN 3120-A 12,5, ISO 1174, with ball locking device



12,5

1/2"

Code	Number	l/mm	Pieces	Weight/g
0770001042100	770-L115GF	430	1	879
0770000922003	770-LE1F	Repair Kit	1	120

770-L1ZI

PUSH THROUGH RATCHET 1/2"

- extremely rugged ratchet with round head
- forged gear wheel with push through square coupler
- smallest possible swivel angle 11,25°
- nonslip QUATROLIT®-2C-handle
- with suspension hole
- matt chrome-plated
- ELORA-Chrome-Vanadium 31CrV3 / 1.2208
- male square according to DIN 3120-A 12,5, ISO 1174, with ball locking device



770-L1V

12,5

1/2"

Code	Number	l/mm	Pieces	Weight/g
0770001062000	770-L1ZI	250	1	525
0770001072000	770-L1V	35	12	44
0770001092001	770-LE1ZI	Repair Kit	1	125

770-LM..., 770-LA..., 770-LW...

SOCKET 1/2", BI-HEXAGON

- hot forged
- chrome-plated, polished
- knurled
- ELORA-Chrome-Vanadium 31CrV3 / 1.2208
- female square according to DIN 3120-C 12,5, ISO 1174, with ball retaining groove
- according to DIN 3124, ISO 2725-1



12,5

1/2"

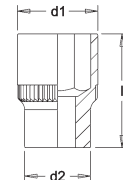

Code	Number	l/mm	d1 mm	d2 mm	Pieces	Weight/g
0770000082000	770-LM 8	40	12,0	23,0	6	56
0770000092000	770-LM 9	40	13,4	23,0	6	56
0770000102000	770-LM 10	40	15,1	23,0	6	56
0770000112000	770-LM 11	40	16,3	23,0	6	58
0770000122000	770-LM 12	40	17,7	23,0	6	58
0770000132000	770-LM 13	40	18,7	23,0	6	58
0770000142000	770-LM 14	40	20,2	23,0	6	60
0770000152000	770-LM 15	40	21,5	23,0	6	62
0770000162000	770-LM 16	40	22,7	23,0	6	66
0770000172000	770-LM 17	40	24,1	23,0	6	66
0770000182000	770-LM 18	40	25,3	23,0	6	66
0770000192000	770-LM 19	40	26,5	23,0	6	66
0770000202000	770-LM 20	40	27,8	23,0	6	72
0770000212000	770-LM 21	40	28,8	24,0	6	74
0770000222000	770-LM 22	40	30,2	23,7	6	86
0770000232000	770-LM 23	40	31,2	24,7	6	88
0770000242000	770-LM 24	40	32,6	24,4	6	96
0770000252000	770-LM 25	42	33,8	25,7	6	106
0770000262000	770-LM 26	42	35,2	24,9	6	108
0770000272000	770-LM 27	44	36,5	26,2	6	126
0770000282000	770-LM 28	44	37,5	27,2	6	140
0770000292000	770-LM 29	44	38,9	27,7	6	145
0770000302000	770-LM 30	44	40,1	28,0	6	150
0770000322000	770-LM 32	46	42,6	28,0	6	180
0770000332000	770-LM 33	46	43,9	28,0	6	180
0770000342000	770-LM 34	46	44,9	29,0	6	195

Code	Number	l/mm	d1 mm	d2 mm	Pieces	Weight/g
0770100172000	770-LA 5/16	40	12,2	23,0	6	56
0770100182000	770-LA 11/32	40	12,8	23,0	6	56
0770100192000	770-LA 3/8	40	13,9	23,0	6	56
0770100202000	770-LA 13/32	40	15,0	23,0	6	56
0770100212000	770-LA 7/16	40	16,3	23,0	6	56
0770100232000	770-LA 1/2	40	18,4	23,0	6	60
0770100242000	770-LA 9/16	40	20,2	23,0	6	62
0770100252000	770-LA 19/32	40	21,5	23,0	6	62
0770100262000	770-LA 5/8	40	22,7	23,0	6	66
0770100262001	770-LA 21/32	40	24,0	23,0	6	66
0770100272000	770-LA 11/16	40	24,7	23,0	6	66
0770100282000	770-LA 3/4	40	26,5	23,0	6	66
0770100292000	770-LA 25/32	40	27,8	23,0	6	72
0770100302000	770-LA 13/16	40	28,4	23,6	6	76
0770100312000	770-LA 7/8	40	30,5	24,0	6	84
0770100322000	770-LA 15/16	42	32,4	23,4	6	92
0770100332000	770-LA 31/32	42	33,3	25,1	6	106
0770100342000	770-LA 1	42	34,3	25,3	6	112
0770100352000	770-LA 1.1/16	44	36,5	26,2	6	130
0770100362000	770-LA 1.1/8	44	38,4	27,2	6	150
0770100372000	770-LA 1.3/16	44	40,1	28,0	6	160
0770100382000	770-LA 1.1/4	46	42,6	28,0	6	170
0770100392000	770-LA 1.5/16	46	44,9	29,0	6	180



Code	Number	l/mm	d1 mm	d2 mm	Pieces	Weight/g
0770200062000	770-LW 1/8	40	12,8	23,0	6	56
0770200092000	770-LW 3/16	40	16,3	23,0	6	58
0770200132000	770-LW 1/4	40	19,4	23,0	6	60
0770200172000	770-LW 5/16	40	21,5	23,0	6	62
0770200192000	770-LW 3/8	40	25,3	23,0	6	64
0770200212000	770-LW 7/16	40	28,8	24,0	6	78
0770200232000	770-LW 1/2	40	31,7	25,2	6	90
0770200242000	770-LW 9/16	42	34,7	25,7	6	108
0770200262000	770-LW 5/8	44	37,5	27,2	6	140
0770200272000	770-LW 11/16	46	40,7	27,0	6	170
0770200282000	770-LW 3/4	46	43,9	28,0	6	180

771-LM.../771-LA...

SOCKET 1/2", HEXAGON

- hot forged
- chrome-plated, polished
- knurled
- ELORA-Chrome-Vanadium 31CrV3 / 1.2208
- female square according to DIN 3120-C 12,5, ISO 1174, with ball retaining groove
- according to DIN 3124, ISO 2725-1



12,5

1/2"

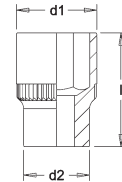

03

Code	Number	l/mm	d1 mm	d2 mm	Pieces	Weight/g
0771000052000	771-LM 5	40	8,2	23,0	6	56
0771000052001	771-LM 5,5	40	9,0	23,0	6	56
0771000062000	771-LM 6	40	9,4	23,0	6	56
0771000072000	771-LM 7	40	11,0	23,0	6	56
0771000082000	771-LM 8	40	12,0	23,0	6	56
0771000092000	771-LM 9	40	13,4	23,0	6	56
0771000102000	771-LM 10	40	15,1	23,0	6	56
0771000112000	771-LM 11	40	16,3	23,0	6	58
0771000122000	771-LM 12	40	17,7	23,0	6	58
0771000132000	771-LM 13	40	18,7	23,0	6	58
0771000142000	771-LM 14	40	20,2	23,0	6	60
0771000152000	771-LM 15	40	21,5	23,0	6	62
0771000162000	771-LM 16	40	22,7	23,0	6	66
0771000172000	771-LM 17	40	24,1	23,0	6	66
0771000182000	771-LM 18	40	25,3	23,0	6	66
0771000192000	771-LM 19	40	26,5	23,0	6	66
0771000202000	771-LM 20	40	27,8	23,0	6	72
0771000212000	771-LM 21	40	28,8	24,0	6	74
0771000222000	771-LM 22	40	30,2	23,7	6	86
0771000232000	771-LM 23	40	31,2	24,7	6	88
0771000242000	771-LM 24	40	32,6	24,8	6	96
0771000252000	771-LM 25	42	33,8	26,1	6	106
0771000262000	771-LM 26	42	35,2	24,9	6	108
0771000272000	771-LM 27	44	36,5	26,2	6	126
0771000282000	771-LM 28	44	37,5	27,2	6	140
0771000292000	771-LM 29	44	38,9	27,7	6	145
0771000302000	771-LM 30	44	40,1	28,0	6	150
0771000322000	771-LM 32	46	42,6	28,0	6	180
0771000332000	771-LM 33	46	43,9	28,0	6	180
0771000342000	771-LM 34	46	44,9	29,0	6	195
0771000362000	771-LM 36	55	49,0	32,0	6	275

Code	Number	l/mm	d1 mm	d2 mm	Pieces	Weight/g
0771100132000	771-LA 1/4	40	10,0	23,0	6	56
0771100172000	771-LA 5/16	40	12,2	23,0	6	56
0771100192000	771-LA 3/8	40	13,9	23,0	6	56
0771100212000	771-LA 7/16	40	16,3	23,0	6	56
0771100232000	771-LA 1/2	40	18,7	23,0	6	60
0771100242000	771-LA 9/16	40	20,2	23,0	6	62
0771100252000	771-LA 19/32	40	21,5	23,0	6	62
0771100262000	771-LA 5/8	40	22,7	23,0	6	66
0771100272000	771-LA 11/16	40	24,7	23,0	6	66
0771100282000	771-LA 3/4	40	26,5	23,0	6	66
0771100292000	771-LA 25/32	40	27,8	23,0	6	72
0771100302000	771-LA 13/16	40	28,4	23,6	6	76
0771100312000	771-LA 7/8	40	30,5	24,0	6	84
0771100322000	771-LA 15/16	42	32,4	24,6	6	92
0771100332000	771-LA 31/32	42	33,3	25,5	6	106
0771100342000	771-LA 1	42	34,3	26,1	6	112
0771100352000	771-LA 1.1/16	44	36,5	26,2	6	130
0771100362000	771-LA 1.1/8	44	38,4	27,2	6	150
0771100372000	771-LA 1.3/16	44	40,1	28,0	6	160
0771100382000	771-LA 1.1/4	46	42,6	28,0	6	170

You will find the matching socket rails on page no. 169



You will find the matching 1/2" plastic holder and additional accessories on page no. 170



770-LT..., 770-LTA...

SOCKET 1/2", EXTRA DEEP, BI-HEXAGON

- especially suitable for deep-set female screws on long threaded bolts
- hot forged
- chrome-plated, polished
- knurled
- ELORA-Chrome-Vanadium 31CrV3 / 1.2208
- female square according to DIN 3120-C 12,5, ISO 1174, with ball retaining groove
- according to DIN 3124, ISO 2725-1

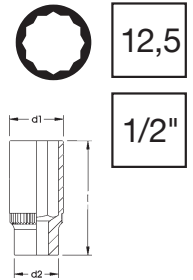

Code	Number	l/mm	d1 mm	d2 mm	Pieces	Weight/g
0770031002000	770-LT 10	80	15,1	23,0	6	104
0770031102000	770-LT 11	80	16,3	23,0	6	106
0770031202000	770-LT 12	80	17,7	23,0	6	108
0770031302000	770-LT 13	80	18,9	23,0	6	122
0770031402000	770-LT 14	80	20,2	23,0	6	130
0770031502000	770-LT 15	80	21,5	23,5	6	130
0770031602000	770-LT 16 / 5/8	80	22,7	24,0	6	130
0770031702000	770-LT 17	80	24,0	23,0	6	135
0770031802000	770-LT 18	80	25,5	23,0	6	155
0770031902000	770-LT 19 / 3/4	80	26,6	23,0	6	155
0770032102000	770-LT 21	80	29,1	23,5	6	185
0770032202000	770-LT 22	80	30,4	24,0	6	190
0770032402000	770-LT 24	80	32,9	24,3	6	220
0770032702000	770-LT 27 / 1.1/16	80	36,0	26,3	6	235
0770033002000	770-LT 30	80	40,5	28,0	6	275
0770033202000	770-LT 32	80	43,0	29,0	6	325
0770033402000	770-LT 34	80	46,0	29,0	6	350

Code	Number	l/mm	d1 mm	d2 mm	Pieces	Weight/g
0770132302000	770-LTA 1/2	80	18,9	23,0	6	130
0770132402000	770-LTA 9/16	80	20,2	23,0	6	130
0770031602000	770-LT 16 / 5/8	80	22,7	24,0	6	130
0770132702000	770-LTA 11/16	80	24,4	23,0	6	140
0770031902000	770-LT 19 / 3/4	80	26,6	23,0	6	155
0770133002000	770-LTA 13/16	80	29,1	23,5	6	185
0770133202000	770-LTA 15/16	80	32,9	24,3	6	220
0770133402000	770-LTA 1	80	34,4	25,0	6	235
0770032702000	770-LT 27 / 1.1/16	80	36,0	26,3	6	235

03

771-LT..., 771-LTA...

SOCKET 1/2", EXTRA DEEP, HEXAGON

- especially suitable for deep-set female screws on long threaded bolts
- hot forged
- chrome-plated, polished
- knurled
- ELORA-Chrome-Vanadium 31CrV3 / 1.2208
- female square according to DIN 3120-C 12,5, ISO 1174, with ball retaining groove
- according to DIN 3124, ISO 2725-1

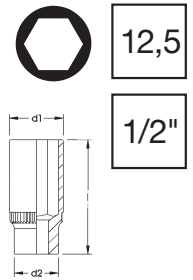

Code	Number	l/mm	d1 mm	d2 mm	Pieces	Weight/g
0771031001000	771-LT 10	80	15,1	23,0	6	104
0771031101000	771-LT 11	80	16,3	23,0	6	106
0771031201000	771-LT 12	80	17,7	23,0	6	108
0771031301000	771-LT 13	80	18,9	23,0	6	122
0771031401000	771-LT 14	80	20,2	23,0	6	130
0771031501000	771-LT 15	80	21,5	23,5	6	130
0771031601000	771-LT 16	80	22,7	24,0	6	130
0771031701000	771-LT 17	80	24,0	23,0	6	135
0771031801000	771-LT 18	80	25,5	23,0	6	155
0771031901000	771-LT 19	80	26,6	23,0	6	155
0771032101000	771-LT 21	80	29,1	23,5	6	185
0771032201000	771-LT 22	80	30,4	24,0	6	190
0771033802000	771-LT 38 / 1.1/2	80	51,5	27,5	6	375

Code	Number	l/mm	d1 mm	d2 mm	Pieces	Weight/g
0771133001000	771-LTA13/16	80	29,1	23,5	6	185
0771132701000	771-LTA11/16	80	24,4	23,0	6	155
0771033802000	771-LT 38 / 1.1/2	80	51,5	27,5	6	375

770-LTXE...

SOCKET 1/2"

- for outside TORX® screws
- hot forged
- chrome-plated, polished
- knurled
- ELORA-Chrome-Vanadium 31CrV3 / 1.2208
- female square according to DIN 3120-C 12,5, ISO 1174, with ball retaining groove
- TORX® = reg. trademark of Acument Intellectual Properties, LLC. USA



12,5

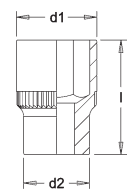

1/2"

Code	Number	★ mm	l/mm	d1 mm	d2 mm	Pieces	Weight/g
0770036102000	770-LTXE 10	9,42	36	15,0	23,0	6	50
0770036112000	770-LTXE 11	10,08	36	15,0	23,0	6	53
0770036122000	770-LTXE 12	11,17	36	17,0	22,0	6	56
0770036142000	770-LTXE 14	12,90	36	19,0	22,0	6	59
0770036162000	770-LTXE 16	14,76	36	21,0	22,0	6	60
0770036182000	770-LTXE 18	16,70	38	21,0	25,0	6	78
0770036202000	770-LTXE 20	18,45	38	24,0	25,0	6	86
0770036242000	770-LTXE 24	22,16	38	28,0	25,0	6	104

03



You will find the matching spark plug sockets on page no. 440



770-L16-17-18

SCREWDRIVER SOCKET 1/2"

- for plain slotted screws
- chrome-plated, polished
- ELORA-Chrome-Vanadium 31CrV3 / 1.2208
- female square according to DIN 3120-C 12,5, ISO 1174
- with ball retaining groove

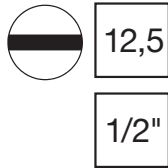

Code	Number	Blade Size mm	l/mm	Pieces	Weight/g
0770016002000	770-L16	24 x 4,0	43	6	86
0770017002000	770-L17	19 x 3,0	43	6	62
0770018002000	770-L18	13 x 2,0	43	6	60

3200-IS...

SCREWDRIVER SOCKET 1/2"

- for plain slotted screws
- chrome-plated, polished
- knurled
- holder made of ELORA-Chrome-Vanadium 31CrV3 / 1.2208
- female square according to DIN 3120-C 12,5, ISO 1174, with ball retaining groove
- blade made of ELORA-Vanadium special steel, gunmetal finished
- blade according to DIN ISO 2380-1 Form B

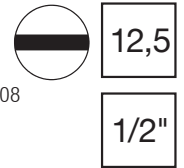

Code	Number	l/mm	l1 mm	d mm	Pieces	Weight/g
3200012082000	3200-IS 1,2x8	62	23,0	23,0	6	80
3200016082000	3200-IS 1,6x8	62	23,0	23,0	6	80
3200016102000	3200-IS 1,6x10	62	23,0	23,0	6	90
3200020122000	3200-IS 2,0x12	62	23,0	23,0	6	120
3200025142000	3200-IS 2,5x14	62	23,0	23,0	6	125

3220-PH...

SCREWDRIVER SOCKET 1/2"

- for cross slotted screws
- chrome-plated, polished
- knurled
- holder made of ELORA-Chrome-Vanadium 31CrV3 / 1.2208
- female square according to DIN 3120-C 12,5, ISO 1174, with ball retaining groove
- blade made of ELORA-Vanadium special steel, gunmetal finished
- blade according to DIN ISO 8764-1 PH

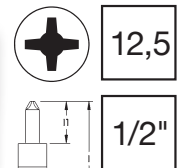

Code	Number	Blade Size mm	l/mm	l1 mm	d mm	Pieces	Weight/g
3220000022000	3220-PH2	3,1-5,2	56	17,0	23,0	6	75
3220000032000	3220-PH3	5,3-7,2	56	17,0	23,0	6	75
3220000042000	3220-PH4	7,3-12,7	56	17,0	23,0	6	80

3225-PZ...

SCREWDRIVER SOCKET 1/2"

- for cross slotted screws
- chrome-plated, polished
- knurled
- holder made of ELORA-Chrome-Vanadium 31CrV3 / 1.2208
- female square according to DIN 3120-C 12,5, ISO 1174, with ball retaining groove
- blade made of ELORA-Vanadium special steel, gunmetal finished
- blade according to DIN ISO 8764-1 PZ

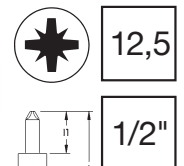

Code	Number	Blade Size mm	l/mm	l1 mm	d mm	Pieces	Weight/g
3225000022000	3225-PZ2	5-10	56	17,0	23,0	6	70
3225000032000	3225-PZ3	12-16	56	17,0	23,0	6	75
3225000042000	3225-PZ 4	18 ->	56	17,0	23,0	6	80

3210-IN..., 3210-INA...

SCREWDRIVER SOCKET 1/2"

- for inside hexagon screws
- chrome-plated, polished
- knurled
- holder made of ELORA-Chrome-Vanadium 31CrV3 / 1.2208
- female square according to DIN 3120-C 12,5, ISO 1174, with ball retaining groove
- blade made of ELORA-Vanadium special steel, gunmetal finished
- according to DIN 7422

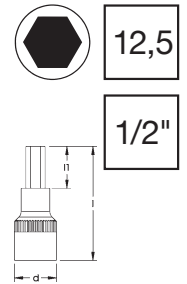

Code	Number	DIN 912	l/mm	l1 mm	d mm	Pieces	Weight/g	Code	Number	l/mm	l1 mm	d mm	Pieces	Weight/g
321000042000	3210-IN 4	M5	60	22,0	23,0	6	65	3210100092000	3210-INA 3/16	52	14,0	23,0	6	75
3210000052000	3210-IN 5	M6	60	22,0	23,0	6	70	3210100112000	3210-INA 7/32	52	14,0	23,0	6	75
3210000062000	3210-IN 6	M8	60	22,0	23,0	6	75	3210100132000	3210-INA 1/4	52	14,0	23,0	6	75
3210000072000	3210-IN 7		60	22,0	23,0	6	85	3210100172000	3210-INA 5/16	52	14,0	23,0	6	75
3210000082000	3210-IN 8	M10	60	22,0	23,0	6	80	3210100192000	3210-INA 3/8	52	14,0	23,0	6	96
3210000092000	3210-IN 9		60	22,0	23,0	6	90	3210100212000	3210-INA 7/16	52	14,0	23,0	6	105
3210000102000	3210-IN 10	M12	60	22,0	23,0	6	90	3210100232000	3210-INA 1/2	52	14,0	23,0	6	110
3210000122000	3210-IN 12	M14	60	22,0	23,0	6	115	3210100242000	3210-INA 9/16	60	20,0	24,0	6	140
3210000142000	3210-IN 14	M16	60	22,0	23,0	6	120	3210100262000	3210-INA 5/8	60	20,0	24,0	6	160
3210000172000	3210-IN 17	M20	60	20,0	24,0	6	160	3210100282000	3210-INA 3/4	60	20,0	24,0	6	205
3210000192000	3210-IN 19	M24	60	20,0	24,0	6	205							
3210000222000	3210-IN 22	M30	60	20,0	24,0	6	227							

3210-INL...

SCREWDRIVER SOCKET 1/2", LONG

- for inside hexagon screws
- chrome-plated, polished
- knurled
- holder made of ELORA-Chrome-Vanadium 31CrV3 / 1.2208
- female square according to DIN 3120-C 12,5, ISO 1174, with ball retaining groove
- blade made of ELORA-Vanadium special steel, gunmetal finished
- according to DIN 7422

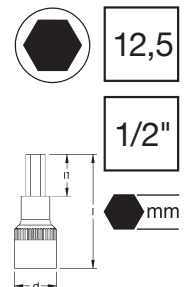

Code	Number	DIN 912	l/mm	l1 mm	d mm	Pieces	Weight/g
3210010052100	3210-INL 5x100	M6	100	62,0	23,0	6	90
3210010052180	3210-INL 5x180	M6	180	142,0	23,0	6	110
3210010062070	3210-INL 6x70	M8	70	32,0	23,0	6	90
3210010062100	3210-INL 6x100	M8	100	62,0	23,0	6	100
3210010062137	3210-INL 6x137	M8	137	99,0	23,0	6	120
3210010062160	3210-INL 6x160	M8	160	122,0	23,0	6	135
3210010062220	3210-INL 6x220	M8	220	182,0	23,0	6	145
3210010072100	3210-INL 7x100	-	100	62,0	23,0	6	90
3210010082083	3210-INL 8x83	M10	83	45,0	23,0	6	90
3210010082100	3210-INL 8x100	M10	100	62,0	23,0	6	100
3210010082120	3210-INL 8x120	M10	120	82,0	23,0	6	120
3210010102140	3210-INL 10x140	M12	140	102,0	23,0	6	140
3210010122140	3210-INL 12x140	M14	140	102,0	23,0	6	180
3210010142140	3210-INL 14x140	M16	140	102,0	23,0	6	240
3210010172100	3210-INL 17x100	M20	100	60,0	24,0	6	230
3210010192100	3210-INL 19x100	M24	100	60,0	24,0	6	295

3210-KUL...

SCREWDRIVER SOCKET 1/2" WITH BALL END, LONG

- for inside hexagon screws
- maximum swivel angle 15°
- chrome-plated, polished
- knurled
- holder made of ELORA-Chrome-Vanadium 31CrV3 / 1.2208
- female square according to DIN 3120-C 12,5, ISO 1174, with ball retaining groove
- blade made of ELORA-Vanadium special steel, gunmetal finished

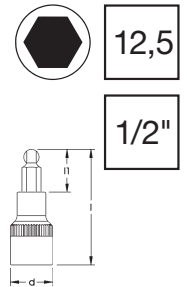

Code	Number	DIN 912 mm	l/mm mm	l1 mm	d mm	Pieces 📦	Weight/g ⚖️
3210020052140	3210-KUL 5	M6	140	102,0	23,0	6	110
3210020062140	3210-KUL 6	M8	140	102,0	23,0	6	120
3210020072140	3210-KUL 7		140	102,0	23,0	6	130
3210020082140	3210-KUL 8	M10	140	102,0	23,0	6	130
3210020102140	3210-KUL 10	M12	140	102,0	23,0	6	140
3210020122140	3210-KUL 12	M14	140	102,0	23,0	6	180

3210-INZ...

SCREWDRIVER SOCKET 1/2", LONG

- for inside hexagon screws with bore hole
- with pin for IC-screws
- chrome-plated, polished
- knurled
- holder made of ELORA-Chrome-Vanadium 31CrV3 / 1.2208
- female square according to DIN 3120-C 12,5, ISO 1174, with ball retaining groove
- blade made of ELORA-Vanadium special steel, gunmetal finished

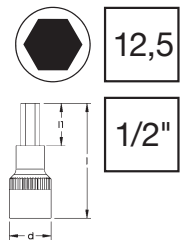

Code	Number	DIN 912 mm	l/mm mm	l1 mm	d mm	Pieces 📦	Weight/g ⚖️
3210050052000	3210-INZ 5	M6	60	22,0	23,0	6	65
3210050062000	3210-INZ 6	M8	60	22,0	23,0	6	75
3210050082000	3210-INZ 8	M10	60	22,0	23,0	6	80
3210050102000	3210-INZ 10	M12	60	22,0	23,0	6	90
3210050122000	3210-INZ 12	M14	60	22,0	23,0	6	115
3210050142000	3210-INZ 14	M16	60	22,0	23,0	6	120

3245-TX...

SCREWDRIVER SOCKET 1/2"

- for inside TORX® screws
- chrome-plated, polished
- knurled
- holder made of ELORA-Chrome-Vanadium 31CrV3 / 1.2208
- female square according to DIN 3120-C 12,5, ISO 1174, with ball retaining groove
- blade made of ELORA-Vanadium special steel, gunmetal finished
- TORX® = reg. trademark of Acument Intellectual Properties, LLC. USA

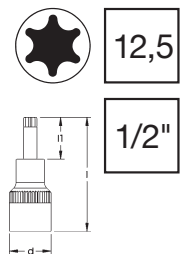

Code	Number	mm	l/mm mm	l1 mm	d mm	Pieces 📦	Weight/g ⚖️
3245000201000	3245-TX 20	3,86	55	17,0	23,0	6	67
3245000251000	3245-TX 25	4,43	55	17,0	23,0	6	68
3245000271000	3245-TX 27	4,99	55	17,0	23,0	6	68
3245000301000	3245-TX 30	5,52	55	17,0	23,0	6	68
3245000401000	3245-TX 40	6,65	55	17,0	23,0	6	69
3245000451000	3245-TX 45	7,82	55	17,0	23,0	6	70
3245000501000	3245-TX 50	8,83	55	17,0	23,0	6	73
3245000551000	3245-TX 55	11,22	56	17,0	23,0	6	112
3245000601000	3245-TX 60	13,25	56	17,0	23,0	6	117

3245-TXL...

SCREWDRIVER SOCKET 1/2", LONG

- for inside TORX® screws
- chrome-plated, polished
- knurled
- holder made of ELORA-Chrome-Vanadium 31CrV3 / 1.2208
- female square according to DIN 3120-C 12,5, ISO 1174, with ball retaining groove
- blade made of ELORA-Vanadium special steel, gunmetal finished
- TORX® = reg. trademark of Acument Intellectual Properties, LLC. USA

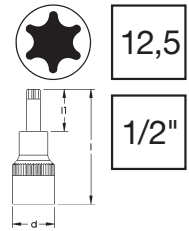

Code	Number	mm	l/mm	l1 mm	d mm	Pieces	Weight/g
3245010201100	3245-TXL 20	3,86	100	62,0	23,0	6	67
3245010251100	3245-TXL 25	4,43	100	62,0	23,0	6	68
3245010271100	3245-TXL 27	4,99	100	62,0	23,0	6	68
3245010301100	3245-TXL 30	5,52	100	62,0	23,0	6	68
3245010401100	3245-TXL 40	6,65	100	62,0	23,0	6	69
3245010451100	3245-TXL 45	7,82	100	62,0	23,0	6	70
3245010451140	3245-TXL 45x140	7,82	140	102,0	23,0	6	145
3245010501100	3245-TXL 50	8,83	100	62,0	23,0	6	73
3245010501000	3245-TXL 50x140	8,83	140	102,0	23,0	6	150
3245010551100	3245-TXL 55	11,22	100	62,0	23,0	6	112
3245010551000	3245-TXL 55x140	11,22	140	102,0	23,0	6	160
3245010601100	3245-TXL 60	13,25	100	62,0	23,0	6	117
3245010701140	3245-TXL 70x140	15,5	140	102,0	23,0	6	175

3245-TTX...

SCREWDRIVER SOCKET 1/2"

- for Inside-TORX® safety screws
- with bore hole in tip
- chrome-plated, polished
- knurled
- holder made of ELORA-Chrome-Vanadium 31CrV3 / 1.2208
- female square according to DIN 3120-C 12,5, ISO 1174, with ball retaining groove
- blade made of ELORA-Vanadium special steel, gunmetal finished
- TORX® = reg. trademark of Acument Intellectual Properties, LLC. USA

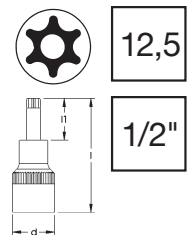

Code	Number	mm	l/mm	l1 mm	d mm	Pieces	Weight/g
3245020201000	3245-TTX 20	3,86	55	17,0	23,0	6	67
3245020251000	3245-TTX 25	4,43	55	17,0	23,0	6	68
3245020271000	3245-TTX 27	4,99	55	17,0	23,0	6	68
3245020301000	3245-TTX 30	5,52	55	17,0	23,0	6	68
3245020401000	3245-TTX 40	6,65	55	17,0	23,0	6	69
3245020451000	3245-TTX 45	7,82	55	17,0	23,0	6	70
3245020501000	3245-TTX 50	8,83	55	17,0	23,0	6	73
3245020551000	3245-TTX 55	11,22	56	17,0	23,0	6	112
3245020601000	3245-TTX 60	13,25	56	17,0	23,0	6	117

3230-XZN...

SCREWDRIVER SOCKET 1/2"

- for inside multi-point B & S and XZN screws
- chrome-plated, polished
- knurled
- holder made of ELORA-Chrome-Vanadium 31CrV3 / 1.2208
- female square according to DIN 3120-C 12,5, ISO 1174, with ball retaining groove
- blade made of ELORA-Vanadium special steel, gunmetal finished
- blade according to DIN 2325
- according to DIN 2324

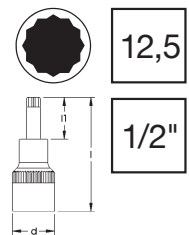

Code	Number	mm	l/mm	l1 mm	d mm	Pieces	Weight/g
3230000052000	3230-XZN 5	M5	52	14,0	23,0	6	75
3230000062000	3230-XZN 6	M6	52	14,0	23,0	6	75
3230000082000	3230-XZN 8	M8	53	15,0	23,0	6	80
3230000102000	3230-XZN 10	M10	53	15,0	23,0	6	85
3230000122000	3230-XZN 12	M12	55	17,0	23,0	6	115
3230000142000	3230-XZN 14	M14	58	20,0	23,0	6	120
3230000162000	3230-XZN 16	M16	60	20,0	24,0	6	152

3230-XZNL...

SCREWDRIVER SOCKET 1/2", EXTRA LONG

- ▶ for inside multi-point B & S and XZN screws
- ▶ chrome-plated, polished
- ▶ knurled
- ▶ holder made of ELORA-Chrome-Vanadium 31CrV3 / 1.2208
- ▶ female square according to DIN 3120-C 12,5, ISO 1174, with ball retaining groove
- ▶ blade made of ELORA-Vanadium special steel, gunmetal finished
- ▶ blade according to DIN 2325
- ▶ according to DIN 2324

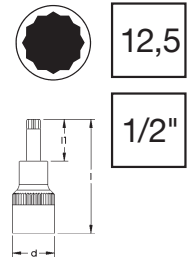

Code	Number	mm	l/mm	l1 mm	d mm	Pieces	Weight/g
3230010062100	3230-XZNL 6x100	M6	100	62,0	23,0	6	95
3230010082080	3230-XZNL 8x80	M8	80	42,0	23,0	6	85
3230010082100	3230-XZNL 8x100	M8	100	62,0	23,0	6	95
3230010082120	3230-XZNL 8x120	M8	120	82,0	23,0	6	100
3230010102100	3230-XZNL 10x100	M10	100	62,0	23,0	6	115
3230010102120	3230-XZNL 10x120	M10	120	82,0	23,0	6	135
3230010102140	3230-XZNL 10x140	M10	140	102,0	23,0	6	140
3230010122100	3230-XZNL 12x100	M12	100	62,0	23,0	6	160
3230010122140	3230-XZNL 12x140	M12	140	102,0	23,0	6	165
3230010142100	3230-XZNL 14x100	M14	100	62,0	23,0	6	165

3240-RIB...

SCREWDRIVER SOCKET 1/2"

- ▶ for RIBE®-CV-screws
- ▶ chrome-plated, polished
- ▶ knurled
- ▶ holder made of ELORA-Chrome-Vanadium 31CrV3 / 1.2208
- ▶ female square according to DIN 3120-C 12,5, ISO 1174, with ball retaining groove
- ▶ blade made of ELORA-Vanadium special steel, gunmetal finished
- ▶ RIBE® = reg. trademark of Richard Bergner GmbH & Co KG, Schwabach

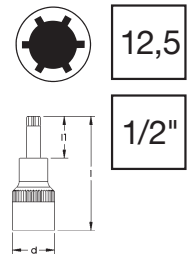

Code	Number	mm	l/mm	l1 mm	d mm	Pieces	Weight/g
3240000082000	3240-RIB 8	M8	63	25,0	23,0	6	80
3240000122000	3240-RIB 12	M12	63	25,0	23,0	6	120
3240000142000	3240-RIB 14	M14	63	25,0	23,0	6	135
3240000162000	3240-RIB 16	M16	63	23,0	24,0	6	130

770-KL/770-MKL

SOCKET RAIL 1/2"

770-KL:

- ▶ 15 shiftable socket clips
- ▶ two holes allow permanent mounting
- ▶ chrome-plated, polished

770-MKL:

- ▶ 14 shiftable socket clips
- ▶ strong magnet enables firm mounting
- ▶ black coated



Code	Number	l/mm	Pieces	Weight/g
0000912146000	770-KL	414	6	80
0000912146001	770-MKL	420	6	269

770-L SB

PLASTIC HOLDER 1/2"

- ▶ appropriate for sockets nominal size 12,5 (1/2") and operation tools with female square



12,5

1/2"

Code	Number	Pieces	Weight/g
0000700127000	770-SB	1	10

770/771-LSP1...

SOCKET DISPLAY DISPENSER

- ▶ heavy gauge sheet steel, black lacquered
- ▶ sockets: knurled, chrome-plated, polished, with ball retaining groove
- ▶ sockets: Chrome-Vanadium 31CrV3 / 1.2208
- ▶ sockets: 1/2" square drive according to DIN 3120/ ISO 1174, for manual drive, sizes according to DIN 3124/ ISO 2725

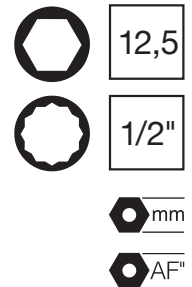

Code	Number	Width mm	Depth mm	Height mm	Contents	Pieces	Weight/g
0770510002000	770-LSP1M	605	380	55	Bi-Hexagon Sockets 770-LM 16 pcs. each 10, 11, 12, 13, 14, 15, 16 mm 15 pcs. 17 mm 14 pcs. each 18, 19 mm 13 pcs. 20 mm 12 pcs. each 21, 22 mm 11 pcs. 24 mm 10 pcs. each 26, 27 mm 9 pcs. 30 mm 8 pcs. 32 mm	1	26000
0771510002000	771-LSP1M	605	380	55	Hexagon Sockets 771-LM 16 pcs. each 10, 11, 12, 13, 14, 15, 16 mm 15 pcs. 17 mm 14 pcs. each 18, 19 mm 13 pcs. 20 mm 12 pcs. each 21, 22 mm 11 pcs. 24 mm 10 pcs. each 26, 27 mm 9 pcs. 30 mm 8 pcs. 32 mm	1	26000
0770610002000	770-LSP1A	605	380	55	Bi-Hexagon Sockets 770-LA 16 pcs. each 3/8, 7/16 AF 32 pcs. each 1/2, 9/16 AF 16 pcs. each 19/32, 5/8 AF 15 pcs. 11/16 AF 14 pcs. 3/4 AF 13 pcs. each 25/32, 13/16 AF 12 pcs. 7/8 AF 11 pcs. 15/16 AF 10 pcs. each 1, 1.1/16 AF 9 pcs. 1.1/8 AF 8 pcs. 1.1/4 AF	1	26000
0770510102000	770-LSP1L	605	380	55	Socket Display Dispenser, empty	1	620

770/771-LSP2...

SOCKET DISPLAY DISPENSER

- ▶ heavy gauge sheet steel, black lacquered
- ▶ sockets: knurled, chrome-plated, polished, with ball retaining groove
- ▶ sockets: Chrome-Vanadium 31 CrV 3, Code-No. 1.2208
- ▶ sockets: 1/2" square drive according to DIN 3120/ ISO 1174, for manual drive, sizes according to DIN 3124/ ISO 2725

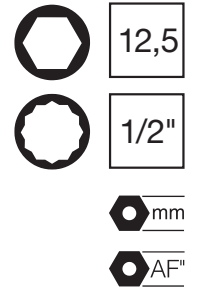

Code	Number	Width mm	Depth mm	Height mm	Contents	Pieces	Weight/g
0770510012000	770-LSP2M	410	135	55	Bi-Hexagon Sockets 770-LM 10 pcs. each 10, 11, 12, 13, 14 mm 9 pcs. 17 mm 8 pcs. 19 mm 7 pcs. each 22, 24 mm 6 pcs. 27 mm 5 pcs. each 30, 32 mm	1	10000
0771510012000	771-LSP2M	410	135	55	Hexagon Sockets 771-LM 10 pcs. each 10, 11, 12, 13, 14 mm 9 pcs. 17 mm 8 pcs. 19 mm 7 pcs. each 22, 24 mm 6 pcs. 27 mm 5 pcs. each 30, 32 mm	1	10000
0770610012000	770-LSP2A	410	135	55	Bi-Hexagon Sockets 770-LA 10 pcs. each 3/8, 7/16, 1/2, 9/16, 5/8 AF 9 pcs. 11/16 AF 8 pcs. 3/4 AF 7 pcs. each 7/8, 15/16 AF 6 pcs. each 1, 1.1/16, 1.1/8 AF	1	10000
0770510112000	770-LSP2L	410	135	55	Socket Display Dispenser, empty	1	2270

770/771-KS1M

ELORA-BIG SPENDER

- ▶ for sockets 3/8 and 1/2 square drive
- ▶ BIG SPENDER 770-KS: with 30 dividers
- ▶ powder coated
- ▶ sockets: Chrome-Vanadium 31CrV3 / 1.2208
- ▶ sockets: 1/2" square drive according to DIN 3120/ ISO 1174, for manual drive, sizes according to DIN 3124/ ISO 2725

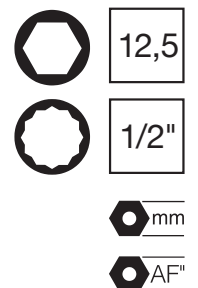

Code	Number	Width mm	Depth mm	Height mm	Contents	Pieces	Weight/g
0770510312000	770-KS1M	470	320	234	Bi-Hexagon Sockets 770-LM 6 pcs. each 8, 9, 10, 11, 12, 13, 14, 15, 16, 17, 18, 19, 20, 21, 22, 23, 24, 25, 26, 27, 28, 30, 32 mm 6 pcs. 770-L11 Socket Converter male 3/4 female 1/2 6 pcs. 770-L13 Socket Converter male 3/8 female 1/2	1	22000
0771510312000	771-KS1M	470	320	234	Hexagon Sockets 771-LM 6 pcs. each 8, 9, 10, 11, 12, 13, 14, 15, 16, 17, 18, 19, 20, 21, 22, 23, 24, 25, 26, 27, 28, 30, 32 mm 6 pcs. 770-L11 Socket Converter male 3/4 female 1/2 6 pcs. 770-L13 Socket Converter male 3/8 female 1/2	1	20500
0770510306000	770-KS	470	320	234	Pin-up Tray, empty	1	8500

770-KS.../AS...

ELORA-BIG SPENDER

- BIG SPENDER: with 2 trays and 30 zinc plated tray dividers
- black powder coated
- pin-up tray: with 16 zinc plated tray dividers
- black powder coated
- sockets: knurled, chrome-plated, polished, with ball retaining groove
- sockets: Chrome-Vanadium 31CrV3 / 1.2208
- sockets: 1/2" square drive according to DIN 3120/ ISO 1174, for manual drive, sizes according to DIN 3124/ ISO 2725

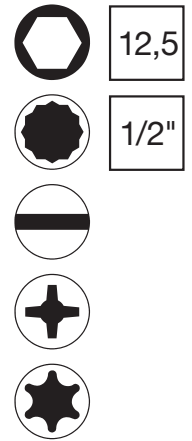

03

Code	Number	Width mm	Depth mm	Height mm	Contents	Pieces	Weight/g
0770510322000	770-KS2M	474	320	270	6 pcs. each Hexagon Screwdriver Socket 3210-IN 4, 5, 6, 7, 8, 9, 10, 12, 14, 17, 19 mm TORX®-Screwdriver Socket 3245-TX 20, 25, 27, 30, 40, 45, 50, 55, 60 mm XZN-B&S Screwdriver Socket 3230-XZN 5, 6, 8, 10, 12, 14 mm Screwdriver Socket cross slotted 3220-PH3 Screwdriver Socket plain slotted 3200-IS 1,6x10 mm	1	24000
0770510422000	770-AS2M	474	320	270	5 pcs. each Hexagon Screwdriver Socket 3210-INL 5x100, 6x70, 6x100, 7x100, 8x83, 8x100, 10x140 mm TORX®-Screwdriver Socket 3245-TXL 50, 55 mm XZN-B&S Screwdriver Socket 3230-XZNL 6x100, 8x100, 10x100, 12x100, 14x100 mm	1	10300
0770510406000	770-AS	474	320	270	pin up top tray , empty	1	2000

You will find the matching 1/2" socket converter on page no. 174



770-L9/770-L10...

FLEXIBLE HANDLE 1/2"

- nonslip QUATROLIT®-2C-handle
- with suspension hole
- matt chrome-plated
- ELORA-Chrome-Vanadium 31CrV3 / 1.2208
- male square according to DIN 3120-A 12,5, ISO 1174, with ball locking device
- according to DIN 3122, ISO 3315



12,5

1/2"

Code	Number	l/mm	Pieces	Weight/g
0770009002000	770-L9	250	3	450
0770010002000	770-L10A	390	3	635
0770010012000	770-L10B	450	3	770

770-L3

SLIDING T-BAR 1/2"

- chrome-plated
- ELORA-Chrome-Vanadium 31CrV3 / 1.2208
- male square according to DIN 3120-A 12,5, ISO 1174, with ball locking device
- according to DIN 3122, ISO 3315



12,5

1/2"

Code	Number	l/mm	Pieces	Weight/g
0770003002000	770-L3	300	4	445

770-L8

OFFSET HANDLE 1/2"

- matt chrome-plated
- ELORA-Chrome-Vanadium 31CrV3 / 1.2208
- male square according to DIN 3120-A 12,5, ISO 1174, with ball locking device
- according to DIN 3122, ISO 3315



12,5

1/2"

Code	Number	l/mm	Pieces	Weight/g
0770008002000	770-L8	190	6	220

770-L2

SPEED BRACE 1/2"

- plastic handle
- matt chrome-plated
- ELORA-Chrome-Vanadium 31CrV3 / 1.2208
- male square according to DIN 3120-A 12,5, ISO 1174, with ball locking device
- according to DIN 3122, ISO 3315



12,5

1/2"

Code	Number	l/mm	Pieces	Weight/g
0770002002000	770-L2	380	6	615

770-L35-L66

EXTENSION BAR 1/2"

- chrome-plated, head polished
- ELORA-Chrome-Vanadium 31CrV3 / 1.2208
- square drive according to DIN 3120, ISO 1174, with ball locking device resp. hole
- according to DIN 3123, ISO 3316

12,5

1/2"



Code	Number	l/mm	Pieces	Weight/g
0770003502000	770-L35	50	6	90
0770004002000	770-L4	75	6	125
0770005002000	770-L5	125	6	190
0770006002000	770-L6	250	6	325
0770006602000	770-L66	500	6	910

770-L...V

EXTENSION BAR 1/2", SWIVELLING

- with special square for a swivel angle of 12,5° to each side
- especially suitable for screw connections within confined spaces
- ELORA-Chrome-Vanadium 31CrV3 / 1.2208
- square drive according to DIN 3120, ISO 1174, with ball locking device resp. hole

12,5

1/2"



Code	Number	l/mm	Pieces	Weight/g
0770004002100	770-L4V	75	6	125
0770005002100	770-L5V	125	6	190
0770005502100	770-L55V	150	6	220
0770006002100	770-L6V	250	6	330

770-L7

UNIVERSAL JOINT 1/2"

- chrome-plated, polished
- ELORA-Chrome-Vanadium 31CrV3 / 1.2208
- square drive according to DIN 3120, ISO 1174, with ball retaining groove resp. with ball locking device
- according to DIN 3123, ISO 3316

12,5

1/2"

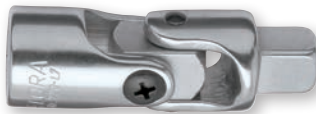

Code	Number	l/mm	Pieces	Weight/g
0770007002000	770-L7	75	6	145

770-L..., 770-S9

SOCKET CONVERTER

- chrome-plated
- ELORA-Chrome-Vanadium 31CrV3 / 1.2208
- square drive according to DIN 3120, ISO 1174,
- according to DIN 3123, ISO 3316

12,5

1/2"



Code	Number	□	○	l/mm	Pieces	Weight/g
0770011002000	770-L11	3/4"	1/2"	45	6	130
0770020902000	770-S9	1/2"	3/4"	57	6	185
0770013002000	770-L13	3/8"	1/2"	40	6	65
0770014002000	770-L14	1/2"	3/8"	36	6	60

You will find the matching radiator drain socket on page no. 436



714-6MU

SOCKET SET 1/4" AND 1/2", COMBINED

- 25 pcs.
- in black metal storage case with plastic insert
- square drive according to DIN 3120, ISO 1174
- operation tools according to DIN 3122, ISO 3315



6,3

1/4"

12,5

1/2"



03

Code	Number	Ratchet	Sockets	Accessories	Pieces	Weight/g
0714562502000	714-6MU	1/4": Reversible Ratchet 1450-1D 1/2": Reversible Ratchet 770-L1D	Hexagon Sockets 1/4": 1455-M 5,5, 6, 7, 8, 9, 10, 11, 12, 13 mm 1/2": 771-LM 10, 13, 15, 17, 19, 22, 24, 27 mm	1/4": Spinner Handle 1450-3 Extension Bar 100 mm 1450-5 Universal Joint 1450-8 1/2": Extension Bar 125 mm 770-L5 Extension Bar 250 mm 770-L6 Universal Joint 770-L7	1	3700

714-6MU OMS

SOCKET SET 1/4" AND 1/2", COMBINED

- 46 pcs.
- in black metal storage case with OMS-hard foam insert
- square drive according to DIN 3120, ISO 1174
- operation tools according to DIN 3122, ISO 3315



6,3



1/4"



12,5



1/2"



Code	Number	Ratchet	Sockets	Accessories	Pieces	Weight/g
0714562502046	714-6MU OMS	1/4": Reversible Ratchet 1450-1D 1/2": Reversible Ratchet 770-L1D	Sockets 1/4" 1455-M 5,5, 6, 7, 8, 9, 10, 11, 12, 13 mm 1455-TXE 4, 5, 6, 7, 8, 10, 11 Hexagon Sockets 1/2" 771-LM 10, 13, 15, 17, 19, 22, 24, 27 mm Screwdriver Sockets 1/4" 3243-TX 8, 9, 10, 15, 20, 25, 27, 30, 40 1455-IN 3, 4, 5, 6, 8 mm	1/4": Spinner Handle 1450-3 Extension Bar 100 mm 1450-5 Universal Joint 1450-8 1/2": Extension Bar 125 mm 770-L5 Extension Bar 250 mm 770-L6 Universal Joint 770-L7	1	3800

770-LK.../771-LK...

SOCKET SET 1/2"

- MU=15 pcs., AU=14 pcs.
- in black metal storage case with plastic insert
- square drive according to DIN 3120, ISO 1174
- operation tools according to DIN 3122, ISO 3315

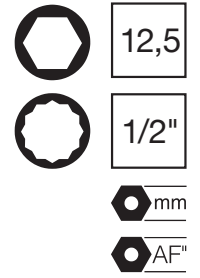

03

Code	Number	Ratchet	Sockets	Accessories	Pieces	Weight/g
0770540402000	770-LKMU	Reversible Ratchet 770-L1D	Bi-Hexagon Sockets 770-LM 10, 11, 12, 13, 14, 15, 16,17, 18, 19, 20, 22 mm	Sliding T-Bar 770-L3 Extension Bar 250 mm 770-L6	1	4000
0771530302000	771-LKMU	Reversible Ratchet 770-L1D	Hexagon Sockets 771-LM 10, 11, 12, 13, 14, 15, 16,17, 18, 19, 20, 22 mm	Sliding T-Bar 770-L3 Extension Bar 250 mm 770-L6	1	4000
0770540402900	770-LKMK	Reversible Ratchet 770-L1K	Bi-Hexagon Sockets 770-LM 10, 11, 12, 13, 14, 15, 16,17, 18, 19, 20, 22 mm	Sliding T-Bar 770-L3 Extension Bar 250 mm 770-L6	1	3900
0771530302900	771-LKMK	Reversible Ratchet 770-L1K	Hexagon Sockets 771-LM 10, 11, 12, 13, 14, 15, 16,17, 18, 19, 20, 22 mm	Sliding T-Bar 770-L3 Extension Bar 250 mm 770-L6	1	3900
0770540412000	770-LKAU	Reversible Ratchet 770-L1D	Bi-Hexagon Sockets 770-LA 7/16, 1/2, 9/16, 19/32, 5/8, 11/16, 3/4, 13/16, 7/8, 15/16, 1 AF	Sliding T-Bar 770-L3 Extension Bar 250 mm 770-L6	1	2935
0771530342000	771-LKAU	Reversible Ratchet 770-L1D	Hexagon Sockets 771-LA 7/16, 1/2, 9/16, 19/32, 5/8, 11/16, 3/4, 13/16, 7/8, 15/16, 1 AF	Sliding T-Bar 770-L3 Extension Bar 250 mm 770-L6	1	3900
0770540412900	770-LKAK	Reversible Ratchet 770-L1K	Bi-Hexagon Sockets 770-LA 7/16, 1/2, 9/16, 19/32, 5/8, 11/16, 3/4, 13/16, 7/8, 15/16, 1 AF	Sliding T-Bar 770-L3 Extension Bar 250 mm 770-L6	1	2940
0771530342900	771-LKAK	Reversible Ratchet 770-L1K	Hexagon Sockets 771-LA 7/16, 1/2, 9/16, 19/32, 5/8, 11/16, 3/4, 13/16, 7/8, 15/16, 1 AF	Sliding T-Bar 770-L3 Extension Bar 250 mm 770-L6	1	3800

770-LIND.../771-LIND...

SOCKET SET 1/2"

- 19 pcs.
- in black metal storage case with plastic insert
- square drive according to DIN 3120, ISO 1174
- operation tools according to DIN 3122, ISO 3315

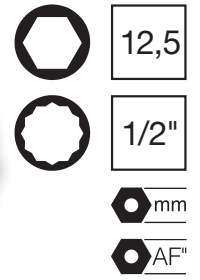

03

Code	Number	Ratchet	Sockets	Accessories	Pieces	Weight/g
0770530302100	770-LINDMF	Reversible Ratchet with safety locking 770-L1F	Bi-Hexagon Sockets 770-LM 10, 11, 12, 13, 14, 15, 16, 17, 19, 22, 24, 27, 30, 32 mm	Sliding T-Bar 770-L3 Extension Bar 125 mm 770-L5 Extension Bar 250 mm 770-L6 Universal Joint 770-L7	1	4300
0771520252000	771-LINDMF	Reversible Ratchet with safety locking 770-L1F	Hexagon Sockets 771-LM 10, 11, 12, 13, 14, 15, 16, 17, 19, 22, 24, 27, 30, 32 mm	Sliding T-Bar 770-L3 Extension Bar 125 mm 770-L5 Extension Bar 250 mm 770-L6 Universal Joint 770-L7	1	4300
0770530302000	770-LINDMU	Reversible Ratchet 770-L1D	Bi-Hexagon Sockets 770-LM 10, 11, 12, 13, 14, 15, 16, 17, 19, 22, 24, 27, 30, 32 mm	Sliding T-Bar 770-L3 Extension Bar 125 mm 770-L5 Extension Bar 250 mm 770-L6 Universal Joint 770-L7	1	4200
0771520202000	771-LINDMU	Reversible Ratchet 770-L1D	Hexagon Sockets 771-LM 10, 11, 12, 13, 14, 15, 16, 17, 19, 22, 24, 27, 30, 32 mm	Sliding T-Bar 770-L3 Extension Bar 125 mm 770-L5 Extension Bar 250 mm 770-L6 Universal Joint 770-L7	1	4300
0770530302900	770-LINDMK	Reversible Ratchet 770-L1K	Bi-Hexagon Sockets 770-LM 10, 11, 12, 13, 14, 15, 16, 17, 19, 22, 24, 27, 30, 32 mm	Sliding T-Bar 770-L3 Extension Bar 125 mm 770-L5 Extension Bar 250 mm 770-L6 Universal Joint 770-L7	1	4200
0771520262000	771-LINDMK	Reversible Ratchet 770-L1K	Hexagon Sockets 771-LM 10, 11, 12, 13, 14, 15, 16, 17, 19, 22, 24, 27, 30, 32 mm	Sliding T-Bar 770-L3 Extension Bar 125 mm 770-L5 Extension Bar 250 mm 770-L6 Universal Joint 770-L7	1	4200
0770530322100	770-LINDAF	Reversible Ratchet with safety locking 770-L1F	Bi-Hexagon Sockets 770-LA 3/8, 7/16, 1/2, 9/16, 19/32, 5/8, 11/16, 3/4, 13/16, 7/8, 1, 1.1/16, 1.1/8, 1.3/16, 1.1/4 AF	Sliding T-Bar 770-L3 Extension Bar 125 mm 770-L5 Extension Bar 250 mm 770-L6 Universal Joint 770-L7	1	4300
0771520272000	771-LINDAF	Reversible Ratchet with safety locking 770-L1F	Hexagon Sockets 771-LA 3/8, 7/16, 1/2, 9/16, 19/32, 5/8, 11/16, 3/4, 13/16, 7/8, 1, 1.1/16, 1.1/8, 1.1/4 AF	Sliding T-Bar 770-L3 Extension Bar 125 mm 770-L5 Extension Bar 250 mm 770-L6 Universal Joint 770-L7	1	4300
0770530322000	770-LINDAU	Reversible Ratchet 770-L1D	Bi-Hexagon Sockets 770-LA 3/8, 7/16, 1/2, 9/16, 19/32, 5/8, 11/16, 3/4, 13/16, 7/8, 1, 1.1/16, 1.1/8, 1.1/4 AF	Sliding T-Bar 770-L3 Extension Bar 125 mm 770-L5 Extension Bar 250 mm 770-L6 Universal Joint 770-L7	1	4400
0771520222000	771-LINDAU	Reversible Ratchet 770-L1D	Hexagon Sockets 771-LA 3/8, 7/16, 1/2, 9/16, 19/32, 5/8, 11/16, 3/4, 13/16, 7/8, 1, 1.1/16, 1.1/8, 1.1/4 AF	Sliding T-Bar 770-L3 Extension Bar 125 mm 770-L5 Extension Bar 250 mm 770-L6 Universal Joint 770-L7	1	4300
0770530322900	770-LINDAK	Reversible Ratchet 770-L1K	Bi-Hexagon Sockets 770-LA 3/8, 7/16, 1/2, 9/16, 19/32, 5/8, 11/16, 3/4, 13/16, 7/8, 1, 1.1/16, 1.1/8, 1.1/4 AF	Sliding T-Bar 770-L3 Extension Bar 125 mm 770-L5 Extension Bar 250 mm 770-L6 Universal Joint 770-L7	1	4200
0771520222900	771-LINDAK	Reversible Ratchet 770-L1K	Hexagon Sockets 771-LA 3/8, 7/16, 1/2, 9/16, 19/32, 5/8, 11/16, 3/4, 13/16, 7/8, 1, 1.1/16, 1.1/8, 1.1/4 AF	Sliding T-Bar 770-L3 Extension Bar 125 mm 770-L5 Extension Bar 250 mm 770-L6 Universal Joint 770-L7	1	4200

770-OK.../771-OK...

SOCKET SET 1/2"

- MU=25 pcs., AU=23 pcs.
- in black metal storage case with plastic insert
- square drive according to DIN 3120, ISO 1174
- operation tools according to DIN 3122, ISO 3315

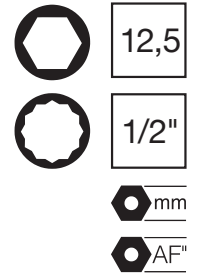

03

Code	Number	Ratchet	Sockets	Accessories	Pieces	Weight/g
0770530122000	770-OKLMU	Reversible Ratchet 770-L1D	Bi-Hexagon Sockets 770-LM 10, 11, 12, 13, 14, 15, 16,17, 18, 19, 20, 21, 22, 23, 24, 25, 26, 27, 30, 32 mm	Sliding T-Bar 770-L3 Extension Bar 125 mm 770-L5 Extension Bar 250 mm 770-L6 Universal Joint 770-L7	1	5200
0771520122000	771-OKLMU	Reversible Ratchet 770-L1D	Hexagon Sockets 771-LM 10, 11, 12, 13, 14, 15, 16,17, 18, 19, 20, 21, 22, 23, 24, 25, 26, 27, 30, 32 mm	Sliding T-Bar 770-L3 Extension Bar 125 mm 770-L5 Extension Bar 250 mm 770-L6 Universal Joint 770-L7	1	5200
0770530122900	770-OKLMK	Reversible Ratchet 770-L1K	Bi-Hexagon Sockets 770-LM 10, 11, 12, 13, 14, 15, 16,17, 18, 19, 20, 21, 22, 23, 24, 25, 26, 27, 30, 32 mm	Sliding T-Bar 770-L3 Extension Bar 125 mm 770-L5 Extension Bar 250 mm 770-L6 Universal Joint 770-L7	1	5100
0771520122900	771-OKLMK	Reversible Ratchet 770-L1K	Hexagon Sockets 771-LM 10, 11, 12, 13, 14, 15, 16,17, 18, 19, 20, 21, 22, 23, 24, 25, 26, 27, 30, 32 mm	Sliding T-Bar 770-L3 Extension Bar 125 mm 770-L5 Extension Bar 250 mm 770-L6 Universal Joint 770-L7	1	5100
0770530222000	770-OKLAU	Reversible Ratchet 770-L1D	Bi-Hexagon Sockets 770-LA 3/8, 7/16, 1/2, 9/16, 19/32, 5/8, 11/16, 3/4, 25/32, 13/16, 7/8, 15/16, 31/32, 1, 1.1/16, 1.1/8, 1.3/16 1.1/4 AF	Sliding T-Bar 770-L3 Extension Bar 125 mm 770-L5 Extension Bar 250 mm 770-L6 Universal Joint 770-L7	1	5100
0771520322000	771-OKLAU	Reversible Ratchet 770-L1D	Hexagon Sockets 771-LA 3/8, 7/16, 1/2, 9/16, 19/32, 5/8, 11/16, 3/4, 25/32, 13/16, 7/8, 15/16, 31/32, 1, 1.1/16, 1.1/8, 1.3/16 1.1/4 AF	Sliding T-Bar 770-L3 Extension Bar 125 mm 770-L5 Extension Bar 250 mm 770-L6 Universal Joint 770-L7	1	5100
0770530222900	770-OKLAK	Reversible Ratchet 770-L1K	Bi-Hexagon Sockets 770-LA 3/8, 7/16, 1/2, 9/16, 19/32, 5/8, 11/16, 3/4, 25/32, 13/16, 7/8, 15/16, 31/32, 1, 1.1/16, 1.1/8, 1.3/16 1.1/4 AF	Sliding T-Bar 770-L3 Extension Bar 125 mm 770-L5 Extension Bar 250 mm 770-L6 Universal Joint 770-L7	1	5000
0771520322900	771-OKLAK	Reversible Ratchet 770-L1K	Hexagon Sockets 771-LA 3/8, 7/16, 1/2, 9/16, 19/32, 5/8, 11/16, 3/4, 25/32, 13/16, 7/8, 15/16, 31/32, 1, 1.1/16, 1.1/8, 1.3/16 1.1/4 AF	Sliding T-Bar 770-L3 Extension Bar 125 mm 770-L5 Extension Bar 250 mm 770-L6 Universal Joint 770-L7	1	5000

770-LM.../771-LM...

SOCKET SET 1/2"

- MU=26 pcs., AU=24 pcs.
- in black metal storage case with plastic insert
- square drive according to DIN 3120, ISO 1174
- operation tools according to DIN 3122, ISO 3315

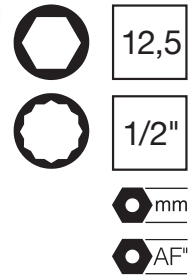

Code	Number	Ratchet	Sockets	Accessories	Pieces	Weight/g
0770530142000	770-LMF	Reversible Ratchet with safety locking 770-L1F	Bi-Hexagon Sockets 770-LM 10, 11, 12, 13, 14, 15, 16,17, 18, 19, 20, 21, 22, 23, 24, 25, 26, 27, 30, 32 mm	Speed Brace 770-L2 Sliding T-Bar 770-L3 Extension Bar 125 mm 770-L5 Extension Bar 250 mm 770-L6 Universal Joint 770-L7	1	5800
0771520152000	771-LMF	Reversible Ratchet with safety locking 770-L1F	Hexagon Sockets 771-LM 10, 11, 12, 13, 14, 15, 16,17, 18, 19, 20, 21, 22, 23, 24, 25, 26, 27, 30, 32 mm	Speed Brace 770-L2 Sliding T-Bar 770-L3 Extension Bar 125 mm 770-L5 Extension Bar 250 mm 770-L6 Universal Joint 770-L7	1	5800
0770530102000	770-LMU	Reversible Ratchet 770-L1D	Bi-Hexagon Sockets 770-LM 10, 11, 12, 13, 14, 15, 16,17, 18, 19, 20, 21, 22, 23, 24, 25, 26, 27, 30, 32 mm	Speed Brace 770-L2 Sliding T-Bar 770-L3 Extension Bar 125 mm 770-L5 Extension Bar 250 mm 770-L6 Universal Joint 770-L7	1	5900
0771520102000	771-LMU	Reversible Ratchet 770-L1D	Hexagon Sockets 771-LM 10, 11, 12, 13, 14, 15, 16,17, 18, 19, 20, 21, 22, 23, 24, 25, 26, 27, 30, 32 mm	Speed Brace 770-L2 Sliding T-Bar 770-L3 Extension Bar 125 mm 770-L5 Extension Bar 250 mm 770-L6 Universal Joint 770-L7	1	5800
0770530102900	770-LMK	Reversible Ratchet 770-L1K	Bi-Hexagon Sockets 770-LM 10, 11, 12, 13, 14, 15, 16,17, 18, 19, 20, 21, 22, 23, 24, 25, 26, 27, 30, 32 mm	Speed Brace 770-L2 Sliding T-Bar 770-L3 Extension Bar 125 mm 770-L5 Extension Bar 250 mm 770-L6 Universal Joint 770-L7	1	5700
0771520102900	771-LMK	Reversible Ratchet 770-L1K	Hexagon Sockets 771-LM 10, 11, 12, 13, 14, 15, 16,17, 18, 19, 20, 21, 22, 23, 24, 25, 26, 27, 30, 32 mm	Speed Brace 770-L2 Sliding T-Bar 770-L3 Extension Bar 125 mm 770-L5 Extension Bar 250 mm 770-L6 Universal Joint 770-L7	1	5700
0770530242000	770-LAF	Reversible Ratchet with safety locking 770-L1F	Bi-Hexagon Sockets 770-LA 3/8, 7/16, 1/2, 9/16, 19/32, 5/8, 11/16, 3/4, 25/32, 13/16, 7/8, 15/16, 31/32, 1, 1.1/16, 1.1/8, 1.3/16, 1.1/4 AF	Speed Brace 770-L2 Sliding T-Bar 770-L3 Extension Bar 125 mm 770-L5 Extension Bar 250 mm 770-L6 Universal Joint 770-L7	1	5700
0771520342000	771-LAF	Reversible Ratchet with safety locking 770-L1F	Hexagon Sockets 771-LA 3/8, 7/16, 1/2, 9/16, 19/32, 5/8, 11/16, 3/4, 25/32, 13/16, 7/8, 15/16, 31/32, 1, 1.1/16, 1.1/8, 1.3/16, 1.1/4 AF	Speed Brace 770-L2 Sliding T-Bar 770-L3 Extension Bar 125 mm 770-L5 Extension Bar 250 mm 770-L6 Universal Joint 770-L7	1	5700
0770530202000	770-LAU	Reversible Ratchet 770-L1D	Bi-Hexagon Sockets 770-LA 3/8, 7/16, 1/2, 9/16, 19/32, 5/8, 11/16, 3/4, 25/32, 13/16, 7/8, 15/16, 31/32, 1, 1.1/16, 1.1/8, 1.3/16, 1.1/4 AF	Speed Brace 770-L2 Sliding T-Bar 770-L3 Extension Bar 125 mm 770-L5 Extension Bar 250 mm 770-L6 Universal Joint 770-L7	1	5600
0771520302000	771-LAU	Reversible Ratchet 770-L1D	Hexagon Sockets 770-LA 3/8, 7/16, 1/2, 9/16, 19/32, 5/8, 11/16, 3/4, 25/32, 13/16, 7/8, 15/16, 31/32, 1, 1.1/16, 1.1/8, 1.3/16, 1.1/4 AF	Speed Brace 770-L2 Sliding T-Bar 770-L3 Extension Bar 125 mm 770-L5 Extension Bar 250 mm 770-L6 Universal Joint 770-L7	1	5700
0770530202900	770-LAK	Reversible Ratchet 770-L1K	Bi-Hexagon Sockets 770-LA 3/8, 7/16, 1/2, 9/16, 19/32, 5/8, 11/16, 3/4, 25/32, 13/16, 7/8, 15/16, 31/32, 1, 1.1/16, 1.1/8, 1.3/16, 1.1/4 AF	Speed Brace 770-L2 Sliding T-Bar 770-L3 Extension Bar 125 mm 770-L5 Extension Bar 250 mm 770-L6 Universal Joint 770-L7	1	5600
0771520302900	771-LAK	Reversible Ratchet 770-L1K	Hexagon Sockets 771-LA 3/8, 7/16, 1/2, 9/16, 19/32, 5/8, 11/16, 3/4, 25/32, 13/16, 7/8, 15/16, 31/32, 1, 1.1/16, 1.1/8, 1.3/16, 1.1/4 AF	Speed Brace 770-L2 Sliding T-Bar 770-L3 Extension Bar 125 mm 770-L5 Extension Bar 250 mm 770-L6 Universal Joint 770-L7	1	5640

770-OKLAMU/771-OKLAMU

SOCKET SET 1/2"

- 27 pcs.
- in black metal storage case with plastic insert
- square drive according to DIN 3120, ISO 1174
- operation tools according to DIN 3122, ISO 3315

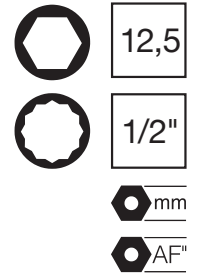

03

Code	Number	Ratchet	Sockets	Accessories	Pieces	Weight/g
0770530422000	770-OKLAMU	Reversible Ratchet 770-L1D	Bi-Hexagon Sockets 770-LM 10, 11, 13, 14, 17, 19, 22, 24, 27, 30, 32 mm 770-LA 7/16, 1/2, 9/16, 19/32, 5/8, 11/16, 3/4, 25/32, 7/8, 15/16, 1 AF	Sliding T-Bar 770-L3 Extension Bar 125 mm 770-L5 Extension Bar 250 mm 770-L6 Universal Joint 770-L7	1	5000
0771520422000	771-OKLAMU	Reversible Ratchet 770-L1D	Hexagon Sockets 771-LM 10, 11, 13, 14, 17, 19, 22, 24, 27, 30, 32 mm 771-LA 7/16, 1/2, 9/16, 19/32, 5/8, 11/16, 3/4, 25/32, 7/8, 15/16, 1 AF	Sliding T-Bar 770-L3 Extension Bar 125 mm 770-L5 Extension Bar 250 mm 770-L6 Universal Joint 770-L7	1	4800

770-LAMU/771-LAMU

SOCKET SET 1/2"

- 28 pcs.
- in black metal storage case with plastic insert
- square drive according to DIN 3120, ISO 1174
- operation tools according to DIN 3122, ISO 3315

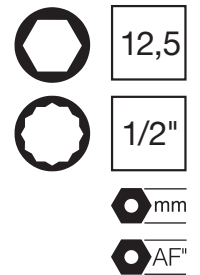

Code	Number	Ratchet	Sockets	Accessories	Pieces	Weight/g
0770530402000	770-LAMU	Reversible Ratchet 770-L1D	Bi-Hexagon Sockets 770-LM 10, 11, 13, 14, 17, 19, 22, 24, 27, 30, 32 mm 770-LA 7/16, 1/2, 9/16, 19/32, 5/8, 11/16, 3/4, 25/32, 7/8, 15/16, 1 AF	Speed Brace 770-L2 Sliding T-Bar 770-L3 Extension Bar 125 mm 770-L5 Extension Bar 250 mm 770-L6 Universal Joint 770-L7	1	5600
0771520402000	771-LAMU	Reversible Ratchet 770-L1D	Hexagon Sockets 771-LM 10, 11, 13, 14, 17, 19, 22, 24, 27, 30, 32 mm 771-LA 7/16, 1/2, 9/16, 19/32, 5/8, 11/16, 3/4, 25/32, 7/8, 15/16, 1 AF	Speed Brace 770-L2 Sliding T-Bar 770-L3 Extension Bar 125 mm 770-L5 Extension Bar 250 mm 770-L6 Universal Joint 770-L7	1	5400

770-LSSMF/771-LSSMF

SOCKET SET 1/2"

- 57 pcs.
- in black metal storage case with OMS-hard foam insert
- square drive according to DIN 3120, ISO 1174
- operation tools according to DIN 3122, ISO 3315

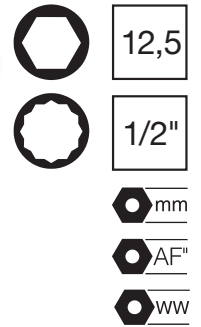

Code	Number	Ratchet	Sockets	Accessories	Pieces	Weight/g
0770530702100	770-LSSMF	Reversible Ratchet with safety locking 770-L1F	Bi-Hexagon Sockets 770-LM 10, 11, 12, 13, 14, 15, 16, 17, 18, 19, 20, 21, 22, 23, 24, 25, 26, 27, 28, 30, 32 mm 770-LA 3/8, 7/16, 1/2, 9/16, 19/32, 5/8, 11/16, 3/4, 25/32, 13/16, 7/8, 15/16, 31/32, 1, 1.1/16, 1.1/8, 1.3/16, 1.1/4 AF 770-LW 3/16, 1/4, 5/16, 3/8, 7/16, 1/2 WW Spark Plug Sockets 771-LTZ 16 (5/8"AF), 771-LTZ 20,8 (13/16"AF) Screwdriver Socket 770-L17 (19x3,0 mm)	Speed Brace 770-L2 Sliding T-Bar 770-L3 Extension Bar 75 mm 770-L4 Extension Bar 125 mm 770-L5 Extension Bar 250 mm 770-L6 Universal Joint 770-L7 Offset Handle 770-L8 Flexible Handle 770-L10A Socket Converter, Male 3/8, Female 1/2 770-L13	1	12800
0771530702100	771-LSSMF	Reversible Ratchet with safety locking 770-L1F	Hexagon Sockets 771-LM 10, 11, 12, 13, 14, 15, 16, 17, 18, 19, 20, 21, 22, 23, 24, 25, 26, 27, 28, 30, 32 mm 771-LA 3/8, 7/16, 1/2, 9/16, 19/32, 5/8, 11/16, 3/4, 25/32, 13/16, 7/8, 15/16, 31/32, 1, 1.1/16, 1.1/8, 1.3/16, 1.1/4 AF Bi-Hexagon Sockets 770-LW 3/16, 1/4, 5/16, 3/8, 7/16, 1/2 WW Spark Plug Sockets 771-LTZ 16 (5/8"AF), 771-LTZ 20,8 (13/16"AF) Screwdriver Socket 770-L17 (19x3,0 mm)	Speed Brace 770-L2 Sliding T-Bar 770-L3 Extension Bar 75 mm 770-L4 Extension Bar 125 mm 770-L5 Extension Bar 250 mm 770-L6 Universal Joint 770-L7 Offset Handle 770-L8 Flexible Handle 770-L10A Socket Converter, Male 3/8, Female 1/2 770-L13	1	13600

770-LTI...

SOCKET SET 1/2"

- 18 pcs.
- in black metal storage case with OMS-hard foam insert
- square drive according to DIN 3120, ISO 1174
- operation tools according to DIN 3122, ISO 3315

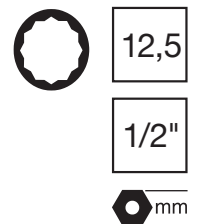

Code	Number	Ratchet	Sockets	Accessories	Pieces	Weight/g
0770514002000	770-LTIU	Reversible Ratchet 770-L1D	Bi-Hexagon Sockets 770-LT 10, 11, 13, 16, 17, 18, 19, 21, 22, 24, 27, 30, 32 mm, extra deep	Sliding T-Bar 770-L3 Extension Bar 125 mm 770-L5 Extension Bar 250 mm 770-L6 Universal Joint 770-L7	1	5555
0770514002900	770-LTIK	Reversible Ratchet 770-L1K	Bi-Hexagon Sockets 770-LT 10, 11, 13, 16, 17, 18, 19, 21, 22, 24, 27, 30, 32 mm, extra deep	Sliding T-Bar 770-L3 Extension Bar 125 mm 770-L5 Extension Bar 250 mm 770-L6 Universal Joint 770-L7	1	5600

770-LTU/LTK

SOCKET SET 1/2"

- 29 pcs.
- in black metal storage case with plastic insert
- square drive according to DIN 3120, ISO 1174
- operation tools according to DIN 3122, ISO 3315

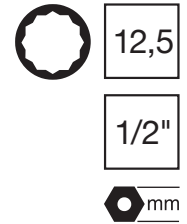

Code	Number	Ratchet	Sockets	Accessories	Pieces	Weight/g
0770515002000	770-LTU	Reversible Ratchet 770-L1D	Bi-Hexagon Sockets 770-LM 10, 11, 12, 13, 14, 15, 16, 17, 19, 22, 24, 27, 30, 32 mm 770-LT 10, 11, 12, 13, 14, 15, 17, 19, 21, 22 mm, extra deep	Sliding T-Bar 770-L3 Extension Bar 125 mm 770-L5 Extension Bar 250 mm 770-L6 Universal Joint 770-L7	1	600
0770515002900	770-LTK	Reversible Ratchet 770-L1K	Bi-Hexagon Sockets 770-LM 10, 11, 12, 13, 14, 15, 16, 17, 19, 22, 24, 27, 30, 32 mm 770-LT 10, 11, 12, 13, 14, 15, 17, 19, 21, 22 mm, extra deep	Sliding T-Bar 770-L3 Extension Bar 125 mm 770-L5 Extension Bar 250 mm 770-L6 Universal Joint 770-L7	1	5800

770-IN...

SOCKET SET 1/2"

- INM=9 pcs., INA=7 pcs., INMTIN=9 pcs. titan-coated
- for inside hexagon screws
- in black metal storage case with plastic insert
- chrome-plated, polished
- knurled
- holder made of ELORA-Chrome-Vanadium 31CrV3 / 1.2208
- female square according to DIN 3120-C 12,5, ISO 1174, with ball retaining groove
- blade made of ELORA-Vanadium special steel, gunmetal finished
- according to DIN 7422



Code	Number	Contents	Pieces	Weight/g
0770550202500	770-INMTIN	Inside-Hexagon Screwdriver Sockets titan coated: IN 4, 5, 6, 8, 10, 12, 14, 17, 19 mm	1	1600
0770550202000	770-INM	Inside-Hexagon Screwdriver Sockets: IN 4, 5, 6, 8, 10, 12, 14, 17, 19 mm	1	1455
0770550252000	770-INA	Inside-Hexagon Screwdriver Sockets: IN 3/16, 1/4, 5/16, 3/8, 1/2, 9/16, 3/4 AF	1	1300

770-KIN...

SOCKET SET 1/2"

- INM=12 pcs., INA=9 pcs.
- for inside hexagon screws
- in black metal storage case with plastic insert
- chrome-plated, polished
- knurled
- holder made of ELORA-Chrome-Vanadium 31CrV3 / 1.2208
- female square according to DIN 3120-C 12,5, ISO 1174, with ball retaining groove
- blade made of ELORA-Vanadium special steel, gunmetal finished
- according to DIN 7422
- operation tools according to DIN 3122, ISO 3315



12,5

1/2"

mm

AF[®]



03

Code	Number	Ratchet	Sockets	Accessories	Pieces	Weight/g
0770550302000	770-KINMU	Reversible Ratchet 770-L1D	Inside Hexagon Screwdriver Sockets 3210-IN 4, 5, 6, 7, 8, 10, 12, 14, 17, 19 mm	Extension Bar 125 mm 770-L5	1	2500
0770550302900	770-KINMK	Reversible Ratchet 770-L1K	Inside Hexagon Screwdriver Sockets 3210-IN 4, 5, 6, 7, 8, 10, 12, 14, 17, 19 mm	Extension Bar 125 mm 770-L5	1	2500
0770550352000	770-KINAU	Reversible Ratchet 770-L1D	Inside Hexagon Screwdriver Sockets 3210-IN 3/16, 1/4, 5/16, 3/8, 1/2, 9/16, 3/4 AF	Extension Bar 125 mm 770-L5	1	2200
0770550352900	770-KINAK	Reversible Ratchet 770-L1K	Inside Hexagon Screwdriver Sockets 3210-IN 3/16, 1/4, 5/16, 3/8, 1/2, 9/16, 3/4 AF	Extension Bar 125 mm 770-L5	1	2200

770-OKLIM/771-OKLIM

Socket Set 1/2"

- 30 pcs.
- in black metal storage case with plastic insert
- square drive according to DIN 3120, ISO 1174
- operation tools according to DIN 3122, ISO 3315

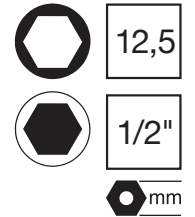

Code	Number	Ratchet	Sockets	Accessories	Pieces	Weight/g
0770550122100	770-OKLIMU	Reversible Ratchet 770-L1D	Bi-Hexagon Sockets 770-LM 10, 11, 12, 13, 14, 15, 16, 17, 18, 19, 21, 22, 23, 24, 26, 27, 30, 32 mm Inside Hexagon Screwdriver Sockets 3210-IN 5, 6, 7, 8, 10, 12, 14 mm	Sliding T-Bar 770-L3 Extension Bar 125 mm 770-L5 Extension Bar 250 mm 770-L6 Universal Joint 770-L7	1	5700
0771530422100	771-OKLIMU	Reversible Ratchet 770-L1D	Hexagon Sockets 771-LM 10, 11, 12, 13, 14, 15, 16, 17, 18, 19, 21, 22, 23, 24, 26, 27, 30, 32 mm Inside Hexagon Screwdriver Sockets 3210-IN 5, 6, 7, 8, 10, 12, 14 mm	Sliding T-Bar 770-L3 Extension Bar 125 mm 770-L5 Extension Bar 250 mm 770-L6 Universal Joint 770-L7	1	5600
0770550122900	770-OKLIMK	Reversible Ratchet 770-L1K	Bi-Hexagon Sockets 770-LM 10, 11, 12, 13, 14, 15, 16, 17, 18, 19, 21, 22, 23, 24, 26, 27, 30, 32 mm Inside Hexagon Screwdriver Sockets 3210-IN 5, 6, 7, 8, 10, 12, 14 mm	Sliding T-Bar 770-L3 Extension Bar 125 mm 770-L5 Extension Bar 250 mm 770-L6 Universal Joint 770-L7	1	5300
0771530422900	771-OKLIMK	Reversible Ratchet 770-L1K	Hexagon Sockets 771-LM 10, 11, 12, 13, 14, 15, 16, 17, 18, 19, 21, 22, 23, 24, 26, 27, 30, 32 mm Inside Hexagon Screwdriver Sockets 3210-IN 5, 6, 7, 8, 10, 12, 14 mm	Sliding T-Bar 770-L3 Extension Bar 125 mm 770-L5 Extension Bar 250 mm 770-L6 Universal Joint 770-L7	1	5300

770-LIM.../771-LIM...

Socket Set 1/2"

- 31 pcs.
- in black metal storage case with plastic insert
- square drive according to DIN 3120, ISO 1174
- operation tools according to DIN 3122, ISO 3315

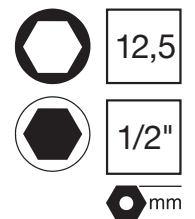

Code	Number	Ratchet	Sockets	Accessories	Pieces	Weight/g
0770550102100	770-LIMU	Reversible Ratchet 770-L1D	Bi-Hexagon Sockets 770-LM 10, 11, 12, 13, 14, 15, 16, 17, 18, 19, 21, 22, 23, 24, 26, 27, 30, 32 mm Inside Hexagon Screwdriver Sockets 3210-IN 5, 6, 7, 8, 10, 12, 14 mm	Speed Brace 770-L2 Sliding T-Bar 770-L3 Extension Bar 125 mm 770-L5 Extension Bar 250 mm 770-L6 Universal Joint 770-L7	1	6000
0771530402100	771-LIMU	Reversible Ratchet 770-L1D	Hexagon Sockets 771-LM 10, 11, 12, 13, 14, 15, 16, 17, 18, 19, 21, 22, 23, 24, 26, 27, 30, 32 mm Inside Hexagon Screwdriver Sockets 3210-IN 5, 6, 7, 8, 10, 12, 14 mm	Speed Brace 770-L2 Sliding T-Bar 770-L3 Extension Bar 125 mm 770-L5 Extension Bar 250 mm 770-L6 Universal Joint 770-L7	1	6700
0770550102900	770-LIMK	Reversible Ratchet 770-L1K	Bi-Hexagon Sockets 770-LM 10, 11, 12, 13, 14, 15, 16, 17, 18, 19, 21, 22, 23, 24, 26, 27, 30, 32 mm Inside Hexagon Screwdriver Sockets 3210-IN 5, 6, 7, 8, 10, 12, 14 mm	Speed Brace 770-L2 Sliding T-Bar 770-L3 Extension Bar 125 mm 770-L5 Extension Bar 250 mm 770-L6 Universal Joint 770-L7	1	5900
0771530402900	771-LIMK	Reversible Ratchet 770-L1K	Hexagon Sockets 771-LM 10, 11, 12, 13, 14, 15, 16, 17, 18, 19, 21, 22, 23, 24, 26, 27, 30, 32 mm Inside Hexagon Screwdriver Sockets 3210-IN 5, 6, 7, 8, 10, 12, 14 mm	Speed Brace 770-L2 Sliding T-Bar 770-L3 Extension Bar 125 mm 770-L5 Extension Bar 250 mm 770-L6 Universal Joint 770-L7	1	5900

770-XZN

Socket Set 1/2"

- 7 pcs.
- for inside multi-point screws
- in black metal storage case with plastic insert
- chrome-plated, polished
- knurled
- holder made of ELORA-Chrome-Vanadium 31CrV3 / 1.2208
- female square according to DIN 3120-C 12,5, ISO 1174, with ball retaining groove
- blade made of ELORA-Vanadium special steel, gunmetal finished
- blades according to DIN 2325



12,5

1/2"

Code	Number	Sockets	Pieces	Weight/g
0770550272000	770-XZN	Screwdriver Sockets: 3230-XZN M5, M6, M8, M10, M12, M14, M16	1	1200

770-KXZN...

Socket Set 1/2"

- 9 pcs.
- for inside multi-point screws
- in black metal storage case with plastic insert
- square drive according to DIN 3120, ISO 1174
- operation tools according to DIN 3122, ISO 3315



12,5

1/2"

Code	Number	Ratchet	Sockets	Accessories	Pieces	Weight/g
0770550402000	770-KXZNU	Reversible Ratchet 770-L1D	Screwdriver Sockets 3230-XZN M5, M6, M8, M10, M12, M14, M16	Extension Bar 125 mm 770-L5	1	2400
0770550402900	770-KXZNK	Reversible Ratchet 770-L1K	Screwdriver Sockets 3230-XZN M5, M6, M8, M10, M12, M14, M16	Extension Bar 125 mm 770-L5	1	2200

770-OKLX.../771-OKLX...

Socket Set 1/2"

- 30 pcs.
- in black metal storage case with plastic insert
- square drive according to DIN 3120, ISO 1174
- operation tools according to DIN 3122, ISO 3315



12,5



1/2"



mm

Code	Number	Ratchet	Sockets	Accessories	Pieces	Weight/g
0770550522100	770-OKLXZNU	Reversible Ratchet 770-L1D	Bi-Hexagon Sockets 770-LM 10, 11, 12, 13, 14, 15, 16, 17, 18, 19, 21, 22, 23, 24, 26, 27, 30, 32 mm Screwdriver Sockets 3230-XZN M5, M6, M8, M10, M12, M14, M16	Sliding T-Bar 770-L3 Extension Bar 125 mm 770-L5 Extension Bar 250 mm 770-L6 Universal Joint 770-L7	1	5400
0771525522100	771-OKLXZNU	Reversible Ratchet 770-L1D	Hexagon Sockets 771-LM 10, 11, 12, 13, 14, 15, 16, 17, 18, 19, 21, 22, 23, 24, 26, 27, 30, 32 mm Screwdriver Sockets 3230-XZN M5, M6, M8, M10, M12, M14, M16	Sliding T-Bar 770-L3 Extension Bar 125 mm 770-L5 Extension Bar 250 mm 770-L6 Universal Joint 770-L7	1	5400
0770550522900	770-OKLXZNK	Reversible Ratchet 770-L1K	Bi-Hexagon Sockets 770-LM 10, 11, 12, 13, 14, 15, 16, 17, 18, 19, 21, 22, 23, 24, 26, 27, 30, 32 mm Screwdriver Sockets 3230-XZN M5, M6, M8, M10, M12, M14, M16	Sliding T-Bar 770-L3 Extension Bar 125 mm 770-L5 Extension Bar 250 mm 770-L6 Universal Joint 770-L7	1	5300
0771525522900	771-OKLXZNK	Reversible Ratchet 770-L1K	Hexagon Sockets 771-LM 10, 11, 12, 13, 14, 15, 16, 17, 18, 19, 21, 22, 23, 24, 26, 27, 30, 32 mm Screwdriver Sockets 3230-XZN M5, M6, M8, M10, M12 M14, M16	Sliding T-Bar 770-L3 Extension Bar 125 mm 770-L5 Extension Bar 250 mm 770-L6 Universal Joint 770-L7	1	5300

770-LX.../771-LX...

Socket Set 1/2"

- 31 pcs.
- in black metal storage case with plastic insert
- square drive according to DIN 3120, ISO 1174
- operation tools according to DIN 3122, ISO 3315

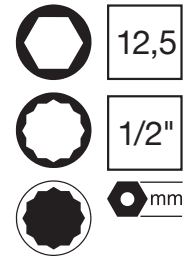

03

Code	Number	Ratchet	Sockets	Accessories	Pieces	Weight/g
0770550502100	770-LXZNU	Reversible Ratchet 770-L1D	Bi-Hexagon Sockets 770-LM 10, 11, 12, 13, 14, 15, 16, 17, 18, 19, 21, 22, 23, 24, 26, 27, 30, 32 mm Screwdriver Sockets 3230-XZN M5, M6, M8, M10, M12 M14, M16	Speed Brace 770-L2 Sliding T-Bar 770-L3 Extension Bar 125 mm 770-L5 Extension Bar 250 mm 770-L6 Universal Joint 770-L7	1	6200
0771525502100	771-LXZNU	Reversible Ratchet 770-L1D	Hexagon Sockets 771-LM 10, 11, 12, 13, 14, 15, 16, 17, 18, 19, 21, 22, 23, 24, 26, 27, 30, 32 mm Screwdriver Sockets 3230-XZN M5, M6, M8, M10, M12 M14, M16	Speed Brace 770-L2 Sliding T-Bar 770-L3 Extension Bar 125 mm 770-L5 Extension Bar 250 mm 770-L6 Universal Joint 770-L7	1	6000
0770550502900	770-LXZNK	Reversible Ratchet 770-L1K	Bi-Hexagon Sockets 770-LM 10, 11, 12, 13, 14, 15, 16, 17, 18, 19, 21, 22, 23, 24, 26, 27, 30, 32 mm Screwdriver Sockets 3230-XZN M5, M6, M8, M10, M12 M14, M16	Speed Brace 770-L2 Sliding T-Bar 770-L3 Extension Bar 125 mm 770-L5 Extension Bar 250 mm 770-L6 Universal Joint 770-L7	1	5900
0771525502900	771-LXZNK	Reversible Ratchet 770-L1K	Hexagon Sockets 771-LM 10, 11, 12, 13, 14, 15, 16, 17, 18, 19, 21, 22, 23, 24, 26, 27, 30, 32 mm Screwdriver Sockets 3230-XZN M5, M6, M8, M10, M12 M14, M16	Speed Brace 770-L2 Sliding T-Bar 770-L3 Extension Bar 125 mm 770-L5 Extension Bar 250 mm 770-L6 Universal Joint 770-L7	1	5900

770-TX/770-TTX

Socket Set 1/2"

- 9 pcs.
- suitable for inside TORX® resp. inside-TORX® safety screws
- in black metal storage case with OMS-hard foam insert
- chrome-plated, polished
- knurled
- holder made of ELORA-Chrome-Vanadium 31CrV3 / 1.2208
- female square according to DIN 3120-C 12,5, ISO 1174, with ball retaining groove
- blade made of ELORA-Vanadium special steel, gunmetal finished
- TORX® = reg. trademark of Acument Intellectual Properties, LLC. USA

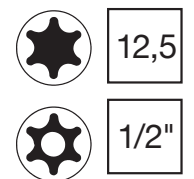

Code	Number	Contents	Pieces	Weight/g
0770551202000	770-TX	TORX®-Screwdriver Sockets: 3245-TX 20, 25, 27, 30, 40, 45, 50, 55, 60	1	1200
0770551252000	770-TTX	TORX®-Screwdriver Sockets: 3245-TTX 20, 25, 27, 30, 40, 45, 50, 55, 60	1	1200

770-TXE

SOCKET SET 1/2"

- 17-pcs.
- suitable for inside- and outside TORX® screws
- in black metal storage case with OMS-hard foam insert
- female square according to DIN 3120-C, 12,5, ISO 1174, with ball retaining groove
- TORX® = reg. trademark of Acument Intellectual Properties, LLC. USA

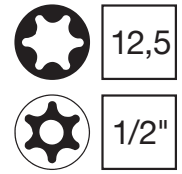

Code	Number	Contents	Pieces	Weight/g
0770510529000	770-TXE	Sockets 1/2" for outside TORX® screws 770-LTXE 10, 11, 12, 14, 16, 18, 20, 24 mm Screwdriver Sockets 1/2" for inside TORX® safety screws 3245-TTX 20, 25, 27, 30, 40, 45, 50, 55, 60 mm	1	3000

03

770-KTX.../KTT...

Socket Set 1/2"

- 11 pcs.
- suitable for inside TORX® resp. inside-TORX® safety screws
- in black metal storage case with plastic insert
- square drive according to DIN 3120, ISO 1174
- operation tools according to DIN 3122, ISO 3315
- TORX® = reg. trademark of Acument Intellectual Properties, LLC. USA



Code	Number	Ratchet	Sockets	Accessories	Pieces	Weight/g
0770551302100	770-KTXU	Reversible Ratchet 770-L1D	TORX®-Screwdriver Sockets 3245-TX 20, 25, 27, 30, 40, 45, 50, 55, 60	Extension Bar 125 mm 770-L5	1	2400
0770551302900	770-KTXK	Reversible Ratchet 770-L1K	TORX®-Screwdriver Sockets 3245-TX 20, 25, 27, 30, 40, 45, 50, 55, 60	Extension Bar 125 mm 770-L5	1	2300
0770551352000	770-KTTXU	Reversible Ratchet 770-L1D	TORX®-Screwdriver Sockets 3245-TTX 20, 25, 27, 30, 40, 45, 50, 55, 60	Extension Bar 125 mm 770-L5	1	2400
0770551352900	770-KTTXK	Reversible Ratchet 770-L1K	TORX®-Screwdriver Sockets 3245-TTX 20, 25, 27, 30, 40, 45, 50, 55, 60	Extension Bar 125 mm 770-L5	1	2300

771-LMIT...

Socket Set 1/2"

- 30 pcs.
- in black metal storage case with plastic insert
- square drive according to DIN 3120, ISO 1174
- operation tools according to DIN 3122, ISO 3315

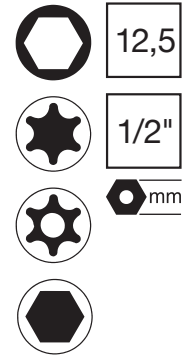

03

Code	Number	Ratchet	Sockets	Accessories	Pieces	Weight/g
0771510602000	771-LMITXU	Reversible Ratchet 770-L1D	Hexagon Sockets 771-LM 10, 11,12, 13, 14, 15, 17, 19, 22, 24, 27, 30 mm Screwdriver Sockets 3210-IN 5, 6, 7, 8, 10, 12, 14 TORX®-Screwdriver Sockets 3245-TX 30, 40, 45, 50	Extension Bar 125 mm 770-L5 Extension Bar 250 mm 770-L6 Universal Joint 770-L7	1	4600
0771510602900	771-LMITXK	Reversible Ratchet 770-L1K	Hexagon Sockets 771-LM 10, 11,12, 13, 14, 15, 17, 19, 22, 24, 27, 30 mm Screwdriver Sockets 3210-IN 5, 6, 7, 8, 10, 12, 14 TORX®-Screwdriver Sockets 3245-TX 30, 40, 45, 50	Extension Bar 125 mm 770-L5 Extension Bar 250 mm 770-L6 Universal Joint 770-L7	1	4500
0771510702000	771-LMITTXU	Reversible Ratchet 770-L1D	Hexagon Sockets 771-LM 10, 11,12, 13, 14, 15, 17, 19, 22, 24, 27, 30 mm Screwdriver Sockets 3210-IN 5, 6, 7, 8, 10, 12, 14 TORX®-Screwdriver Sockets 3245-TTX 30, 40, 45, 50	Extension Bar 125 mm 770-L5 Extension Bar 250 mm 770-L6 Universal Joint 770-L7	1	4500
0771510702900	771-LMITTXK	Reversible Ratchet 770-L1K	Hexagon Sockets 771-LM 10, 11,12, 13, 14, 15, 17, 19, 22, 24, 27, 30 mm Screwdriver Sockets 3210-IN 5, 6, 7, 8, 10, 12, 14 TORX®-Screwdriver Sockets 3245-TTX 30, 40, 45, 50	Extension Bar 125 mm 770-L5 Extension Bar 250 mm 770-L6 Universal Joint 770-L7	1	4500



You will find the matching OMS-3/4 module on page no. 47

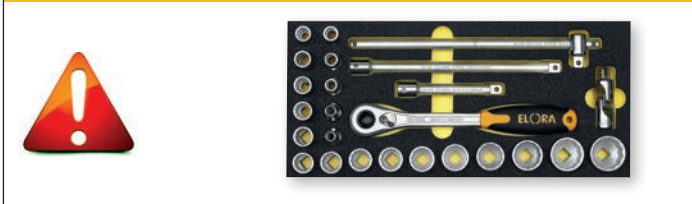

You will find the matching OMS-18 module on page no. 48

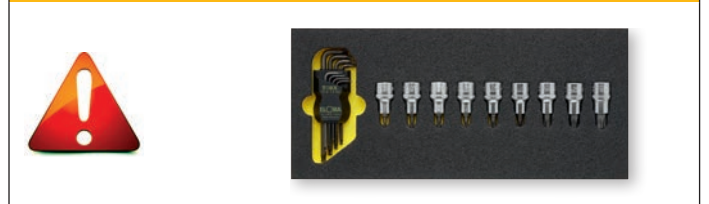

You will find the matching OMS-11/12 module on page no. 60



You will find the matching MS-13 module on page no. 61

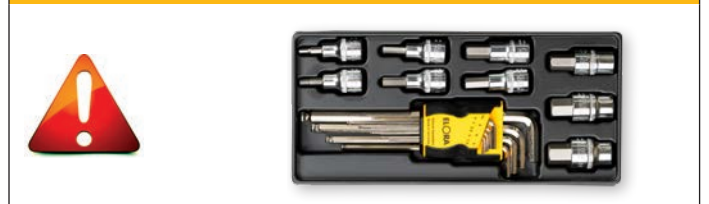

You will find the matching MS-14 module on page no. 61



770-S1K
Reversible Ratchet Head 3/4"

- for use with tommy bar ELORA-No. 770-S7
- forged gear with male and female coupler square
- smallest possible swivel angle 11,25°
- matt chrome-plated
- ELORA-Chrome-Vanadium 31CrV3 / 1.2208
- square drive according to DIN 3120-B 20, ISO 1174, with locking pin
- according to DIN 3122, ISO 3315



20

3/4"

Code	Number	l/mm	Pieces	Weight/g
0770020122000	770-S1K	160	1	1365
0770020702000	770-S7	500	3	1335
0770021602000	770-S16	Repair Kit	1	530

770-S1U
REVERSIBLE RATCHET 3/4"

- forged gear with male and female coupler square
- smallest possible swivel angle 11,25°
- matt chrome-plated
- ELORA-Chrome-Vanadium 31CrV3 / 1.2208
- square drive according to DIN 3120-B 20, ISO 1174, with locking pin
- according to DIN 3122, ISO 3315



20

3/4"

Code	Number	l/mm	Pieces	Weight/g
0770020102000	770-S1U	500	1	1980
0770021602000	770-S16	Repair Kit	1	530

770-S1ZI
PUSH THROUGH RATCHET 3/4"

- forged gear wheel with push through square coupler
- with suspension hole
- smallest possible swivel angle 10°
- matt chrome-plated
- ELORA-Chrome-Vanadium 31CrV3 / 1.2208
- square drive according to DIN 3120-A 20, ISO 1174, with ball retaining groove



20

3/4"

Code	Number	l/mm	Pieces	Weight/g
0770020112100	770-S1ZI	500	1	1383
0770020132000	770-S1V	42	6	135
0770021702000	770-S17	Repair Kit	1	340

770SM-..., 770SA-..., 770SW-...

SOCKET 3/4", BI-HEXAGON

- hot forged
- matt chrome-plated
- knurled
- ELORA-Chrome-Vanadium 31CrV3 / 1.2208
- female square according to DIN 3120-D 20, ISO 1174, with locking pin
- according to DIN 3124, ISO 2725-1



Code	Number	d1 mm	d2 mm	l/mm	Pieces	Weight/g
0770010182000	770-S 18	27,0	35,0	50,0	3	170
0770010192000	770-S 19	28,0	35,0	50,0	3	170
0770010212000	770-S 21	30,6	35,0	50,5	3	180
0770010222000	770-S 22	32,2	35,0	50,5	3	190
0770010232000	770-S 23	33,5	35,0	51,0	3	200
0770010242000	770-S 24	34,5	35,0	52,0	3	190
0770010252000	770-S 25	37,0	35,0	53,0	3	220
0770010262000	770-S 26	38,0	36,0	53,0	3	235
0770010272000	770-S 27	38,6	36,0	55,0	3	230
0770010282000	770-S 28	40,0	36,0	55,5	3	260
0770010292000	770-S 29	41,0	37,0	55,5	3	275
0770010302000	770-S 30	43,0	37,0	57,0	3	290
0770010322000	770-S 32	45,3	38,0	58,5	3	330
0770010332000	770-S 33	46,3	39,0	59,5	3	350
0770010342000	770-S 34	46,8	39,0	59,5	3	360
0770010362000	770-S 36	50,7	40,0	61,0	3	430
0770010372000	770-S 37	51,7	41,0	61,5	3	470
0770010382000	770-S 38 / 1.1/2	53,2	41,0	62,0	3	510
0770010412000	770-S 41	56,0	40,0	64,0	3	605
0770010422000	770-S 42	57,0	40,0	64,0	3	570
0770010462000	770-S 46 / 1.13/16	66,0	42,0	66,0	3	720
0770010472000	770-S 47	63,0	42,0	68,0	1	730
0770010502000	770-S 50	68,0	42,0	68,0	1	840
0770010522000	770-S 52	71,0	45,0	72	1	965
0770010542000	770-S 54	72,0	45,0	74,0	1	955
0770010552000	770-S 55	74,0	45,0	76,0	1	1110
0770010602000	770-S 60	80,0	45,0	78,0	1	1345



Code	Number	d1 mm	d2 mm	l/mm	Pieces	Weight/g
0770210232000	770-SW 1/2	33,5	35,0	51,0	3	190
0770210242000	770-SW 9/16	37,0	35,0	53,0	3	215
0770210262000	770-SW 5/8	40,0	36,0	55,5	3	225
0770210272000	770-SW 11/16	43,0	37,0	57,0	3	290
0770210282000	770-SW 3/4	46,3	39,0	59,5	3	300
0770210302000	770-SW 13/16	48,9	40,0	60,5	1	385
0770210312000	770-SW 7/8	52,3	41,0	61,5	1	445
0770210322000	770-SW 15/16	55,4	42,0	62,5	1	555
0770210342000	770-SW 1	58,3	41,0	63,5	1	600
0770210362000	770-SW 1.1/8	65,0	45,0	73	1	775

Code	Nummer	d1 mm	d2 mm	l/mm	Stück	Gewicht/g
0770110282000	770-SA 3/4	28,0	35,0	50,0	3	170
0770110302000	770-SA 13/16	30,5	35,0	50,0	3	185
0770110312000	770-SA 7/8	32,5	35,0	50,0	3	190
0770110322000	770-SA 15/16	34,5	35,0	52,0	3	190
0770110332000	770-SA 31/32	35,0	35,0	53,0	3	190
0770110342000	770-SA 1	37,0	35,0	53,0	3	215
0770110352000	770-SA 1.1/16	38,6	36,0	55,0	3	235
0770110362000	770-SA 1.1/8	40,7	36,0	55,5	3	245
0770110372000	770-SA 1.3/16	43,0	37,0	57,0	3	255
0770110382000	770-SA 1.1/4	45,3	38,0	58,5	3	335
0770110392000	770-SA 1.5/16	46,3	39,0	59,5	3	350
0770110402000	770-SA 1.3/8	48,9	40,0	60,5	3	395
0770110412000	770-SA 1.7/16	50,7	40,0	62,0	3	435
0770010382000	770-S 38 / 1.1/2	53,2	41,0	62,0	3	510
0770110432000	770-SA 1.9/16	55,4	42,0	62,5	3	540
0770110442000	770-SA 1.5/8	56,0	40,0	64,0	3	585
0770110452000	770-SA 1.11/16	58,0	40,0	65,0	3	615
0770110462000	770-SA 1.3/4	60,0	40,0	66,0	3	600
0770010462000	770-S 46 / 1.13/16	62,0	42,0	66,0	3	720
0770110482000	770-SA 1.7/8	64,0	42,0	68,0	1	720
0770110492000	770-SA 2	68,0	42,0	68,0	1	895
0770110502000	770-SA 2.1/16	70,0	45,0	72,0	1	950
0770110512000	770-SA 2.1/8	72,0	45,0	74,0	1	1045
0770110522000	770-SA 2.3/16	74,0	45,0	76,0	1	1095
0770110532000	770-SA 2.1/4	76,0	45,0	76,0	1	1220
0770110552000	770-SA 2.3/8	80,0	45,0	78,0	1	1380

771-S...

SOCKET 3/4", HEXAGON

- hot forged
- matt chrome-plated
- knurled
- ELORA-Chrome-Vanadium 31CrV3 / 1.2208
- female square according to DIN 3120-D 20, ISO 1174 with locking pin
- according to DIN 3124, ISO 2725-1

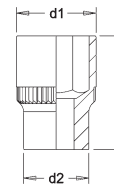

20

3/4"

mm

03

Code	Number	d1 mm	d2 mm	l/mm	Pieces	Weight/g
0771010182000	771-S 18	27,0	35,0	50,0	3	170
0771010192000	771-S 19	28,0	35,0	50,0	3	170
0771010212000	771-S 21	30,6	35,0	50,5	3	180
0771010222000	771-S 22	32,2	35,0	50,5	3	190
0771010232000	771-S 23	33,5	35,0	51,0	3	200
0771010242000	771-S 24	34,5	35,0	52,0	3	190
0771010252000	771-S 25	37,0	35,0	53,0	3	220
0771010262000	771-S 26	38,0	36,0	54,0	3	235
0771010272000	771-S 27	38,6	36,0	55,0	3	230
0771010282000	771-S 28	40,0	36,0	55,5	3	260
0771010292000	771-S 29	41,0	37,0	57	3	275
0771010302000	771-S 30	43,0	37,0	57,0	3	290
0771010322000	771-S 32	45,3	38,0	58,5	3	330
0771010332000	771-S 33	46,3	39,0	59,5	3	350
0771010342000	771-S 34	46,8	39,0	59,5	3	360
0771010362000	771-S 36	50,7	40,0	61,0	3	430
0771010372000	771-S 37	51,7	41,0	61,5	3	470
0771010382000	771-S 38 / 1.1/2	53,2	41,0	62,0	3	510
0771010412000	771-S 41	56,0	40,0	64,0	3	605
0771010422000	771-S 42	57,0	40,0	64,0	3	570
0771010462000	771-S 46 / 1.13/16	62,0	42,0	66,0	3	720
0771010472000	771-S 47	63,0	42,0	68,0	1	730
0771010502000	771-S 50	68,0	42,0	68,0	1	840
0771010552000	771-S 55	74,0	45,0	76,0	1	1110
0771010602000	771-S 60	80,0	45,0	78,0	1	1345

770-SIN...

SCREWDRIVER SOCKET 3/4"

- for inside hexagon screws
- matt chrome-plated
- knurled
- holder made of ELORA-Chrome-Vanadium 31CrV3 / 1.2208
- female square according to DIN 3120-D 20, ISO 1174, with locking pin
- blade made of ELORA-Vanadium special steel, gunmetal finished
- according to DIN 7422

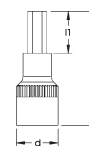

20

3/4"

mm

Code	Number	DIN 912 mm	d mm	l1 mm	l/mm	Pieces	Weight/g
0770050142000	770-SIN 14	M16-18	36,0	25,5	76,5	3	180
0770050172000	770-SIN 17	M20-22	36,0	25,5	76,5	3	190
0770050192000	770-SIN 19	M24-27	36,0	25,5	76,5	3	200
0770050222000	770-SIN 22	M30	36,0	25,5	76,5	3	215

770-S2

FLEXIBLE HANDLE 3/4"

- matt chrome-plated
- with plastic handle
- ELORA-Chrome-Vanadium 31 CrV 3 / 1.2208
- male square according to DIN 3120-B 20, ISO 1174, with locking pin
- according to DIN 3122, ISO 3315



20

3/4"

Code	Number	l/mm	Pieces	Weight/g
0770020202000	770-S2	500	1	1670

770-S3

SLIDING T-BAR 3/4"

- matt chrome-plated
- ELORA-Chrome-Vanadium 31CrV3 / 1.2208
- male square according to DIN 3120-B 20, ISO 1174, with locking pin
- according to DIN 3122, ISO 3315



20

3/4"

Code	Number	l/mm	Pieces	Weight/g
0770020302000	770-S3	480	2	1447

770-S14

SOCKET HANDLE 3/4"

- matt chrome-plated
- with plastic handle
- ELORA-Chrome-Vanadium 31 CrV 3 / 1.2208
- male square according to DIN 3120-B 20, ISO 1174, with locking pin
- according to DIN 3122, ISO 3315



20

3/4"

Code	Number	l/mm	Pieces	Weight/g
0770021402000	770-S14	500	1	1809

770-S4/-S5/-S15

EXTENSION BAR 3/4"

- matt chrome-plated
- ELORA-Chrome-Vanadium 31 CrV 3 / 1.2208
- square drive according to DIN 3120, ISO 1174, with locking pin
- according to DIN 3123, ISO 3316



20

3/4"

Code	Number	l/mm	Pieces	Weight/g
0770021502000	770-S15	100	6	335
0770020402000	770-S4	200	6	590
0770020502000	770-S5	400	3	1085

770-S6

UNIVERSAL JOINT 3/4"

- chrome-plated, polished
- ELORA-Chrome-Vanadium 31CrV3 / 1.2208
- square drive according to DIN 3120, ISO 1174, with locking pin
- according to DIN 3123, ISO 3316



20

3/4"

Code	Number	l/mm	Pieces	Weight/g
0770020602000	770-S6	100	1	465

770-S13

SLIDING HEAD 3/4"

- ▶ for use with tommy bar ELORA-No. 770-S7
- ▶ ELORA-Chrome-Vanadium 31 CrV 3 / 1.2208
- ▶ male square according to DIN 3120-B 20, ISO 1174, with locking pin

20

3/4"



770-S8

FLEXIBLE HEAD 3/4"

- ▶ for use with tommy bar ELORA-No. 770-S7
- ▶ ELORA-Chrome-Vanadium 31 CrV 3 / 1.2208
- ▶ male square according to DIN 3120-B 20, ISO 1174, with locking pin

20

3/4"



03

Code	Number	l/mm	Pieces	Weight/g
0770021302000	770-S13	65	3	300

Code	Number	l/mm	Pieces	Weight/g
0770020802000	770-S8	110	1	693

770-S7

TOMMY BAR 3/4"

- ▶ with plastic handle
- ▶ for ELORA-No.770-S1K, Reversible Ratchet Head
- ▶ for ELORA-Nr.770-S8, Flexible Head
- ▶ for ELORA-Nr.770-S13, Sliding Head
- ▶ for ELORA-Chrome-Vanadium 31CrV3 / 1.2208



Code	Number	l/mm	Pieces	Weight/g
0770020702000	770-S7	500	3	1335

770-L11/-S.../780-7

SOCKET CONVERTER 3/4"

- ▶ chrome-plated
- ▶ ELORA-Chrome-Vanadium 31CrV3 / 1.2208
- ▶ square drive according to DIN 3120, ISO 1174
- ▶ according to DIN 3123, ISO 3316

20

3/4"



Code	Number	□	○	l/mm	Pieces	Weight/g
0770020902000	770-S9	1/2"	3/4"	57	6	185
0770011002000	770-L11	3/4"	1/2"	45	6	130
0770021102000	770-S11	1	3/4"	55	6	255
0780100072000	780-7	3/4"	1	70	1	425

770-S10 OK.../771-S10 OK...

SOCKET SET 3/4"

- 13 pcs.
- in black metal storage case
- square drive according to DIN 3120, ISO 1174, with locking pin
- operation tools according to DIN 3122, ISO 3315

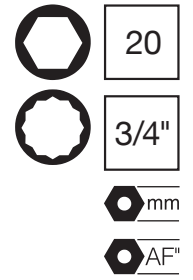

Code	Number	Sockets	Accessories	Pieces	Weight/g
0770580102000	770-S10 OKM	Bi-Hexagon Sockets 770-SM 22, 24, 27, 30, 32, 36, 38, 41, 46, 50 mm	Sliding T-Bar 770-S3 Extension Bar 200 mm 770-S4 Extension Bar 400 mm 770-S5	1	10800
0771540102000	771-S10 OKM	Hexagon Sockets 771-SM 22, 24, 27, 30, 32, 36, 38, 41, 46, 50 mm	Sliding T-Bar 770-S3 Extension Bar 200 mm 770-S4 Extension Bar 400 mm 770-S5	1	11200
0770580112000	770-S10 OKA	Bi-Hexagon Sockets 770-SA 7/8, 15/16, 1, 1.1/16, 1.1/4, 1.7/16, 1.1/2, 1.5/8, 1.13/16, 2 AF	Sliding T-Bar 770-S3 Extension Bar 200 mm 770-S4 Extension Bar 400 mm 770-S5	1	10600

770-S10.../771-S10...

SOCKET SET 3/4"

- 14 pcs.
- in black metal storage case
- square drive according to DIN 3120, ISO 1174, with locking pin
- operation tools according to DIN 3122, ISO 3315

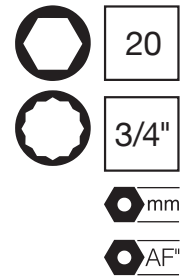

Code	Number	Ratchet	Sockets	Accessories	Pieces	Weight/g
0770580122000	770-S10 MU	Reversible Ratchet 770-S1U	Bi-Hexagon Sockets 770-SM 22, 24, 27, 30, 32, 36, 38, 41, 46, 50 mm	Sliding T-Bar 770-S3 Extension Bar 200 mm 770-S4 Extension Bar 400 mm 770-S5	1	12700
0771540112000	771-S10 MU	Reversible Ratchet 770-S1U	Hexagon Sockets 771-SM 22, 24, 27, 30, 32, 36, 38, 41, 46, 50 mm	Sliding T-Bar 770-S3 Extension Bar 200 mm 770-S4 Extension Bar 400 mm 770-S5	1	12700
0770580132000	770-S10 MZ	Push Through Ratchet 770-S1ZI	Bi-Hexagon Sockets 770-SM 22, 24, 27, 30, 32, 36, 38, 41, 46, 50 mm	Sliding T-Bar 770-S3 Extension Bar 200 mm 770-S4 Extension Bar 400 mm 770-S5	1	12100
0771540122000	771-S10 MZ	Push Through Ratchet 770-S1ZI	Hexagon Sockets 771-SM 22, 24, 27, 30, 32, 36, 38, 41, 46, 50 mm	Sliding T-Bar 770-S3 Extension Bar 200 mm 770-S4 Extension Bar 400 mm 770-S5	1	12100
0770580142000	770-S10 AU	Reversible Ratchet 770-S1U	Bi-Hexagon Sockets 770-SA 7/8, 15/16, 1, 1.1/16, 1.1/4, 1.7/16, 1.1/2, 1.5/8, 1.13/16, 2 AF	Sliding T-Bar 770-S3 Extension Bar 200 mm 770-S4 Extension Bar 400 mm 770-S5	1	12600
0770580152000	770-S10 AZ	Push Through Ratchet 770-S1ZI	Bi-Hexagon Sockets 770-SA 7/8, 15/16, 1, 1.1/16, 1.1/4, 1.7/16, 1.1/2, 1.5/8, 1.13/16, 2 AF	Sliding T-Bar 770-S3 Extension Bar 200 mm 770-S4 Extension Bar 400 mm 770-S5	1	12000

770-S10 K.../771-S10 K...

SOCKET SET 3/4"

- 16 pcs.
- in black metal storage case
- square drive according to DIN 3120, ISO 1174, with locking pin
- operation tools according to DIN 3122, ISO 3315

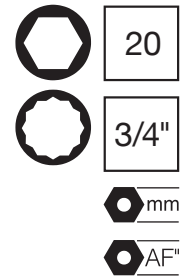

03

Code	Number	Ratchet	Sockets	Accessories	Pieces	Weight/g
0770580162000	770-S10 KM	Reversible Ratchet Head 770-S1K	Bi-Hexagon Sockets 770-SM 22, 24, 27, 30, 32, 36, 38, 41, 46, 50 mm	Sliding T-Bar 770-S3 Extension Bar 200 mm 770-S4 Extension Bar 400 mm 770-S5 Tommy Bar 770-S7 Universal Joint 770-S8	1	14000
0771540132000	771-S10 KM	Reversible Ratchet Head 770-S1K	Hexagon Sockets 771-SM 22, 24, 27, 30, 32, 36, 38, 41, 46, 50 mm	Sliding T-Bar 770-S3 Extension Bar 200 mm 770-S4 Extension Bar 400 mm 770-S5 Tommy Bar 770-S7 Universal Joint 770-S8	1	14500
0770580172000	770-S10 KA	Reversible Ratchet Head 770-S1K	Bi-Hexagon Sockets 770-SA 7/8, 15/16, 1, 1.1/16, 1.1/4, 1.7/16, 1.1/2, 1.5/8, 1.13/16, 2 AF	Sliding T-Bar 770-S3 Extension Bar 200 mm 770-S4 Extension Bar 400 mm 770-S5 Tommy Bar 770-S7 Universal Joint 770-S8	1	13900

770-S12.../771-S12...

SOCKET SET 3/4"

- 16 pcs.
- in black metal storage case
- square drive according to DIN 3120, ISO 1174, with locking pin
- operation tools according to DIN 3122, ISO 3315

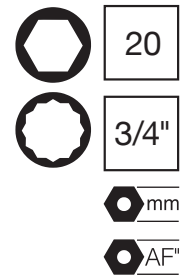

Code	Number	Ratchet	Sockets	Accessories	Pieces	Weight/g
0770580182000	770-S12 MU	Reversible Ratchet 770-S1U	Bi-Hexagon Sockets 770-SM 22, 24, 27, 30, 32, 36, 38, 41, 46, 50, 55, 60 mm	Sliding T-Bar 770-S3 Extension Bar 200 mm 770-S4 Extension Bar 400 mm 770-S5	1	13900
0771540142000	771-S12 MU	Reversible Ratchet 770-S1U	Hexagon Sockets 771-SM 22, 24, 27, 30, 32, 36, 38, 41, 46, 50, 55, 60 mm	Sliding T-Bar 770-S3 Extension Bar 200 mm 770-S4 Extension Bar 400 mm 770-S5	1	15900
0770580192000	770-S12 AU	Reversible Ratchet 770-S1U	Bi-Hexagon Sockets 770-SA 3/4, 13/16, 7/8, 15/16, 1, 1.1/16, 1.1/4, 1.7/16, 1.1/2, 1.5/8, 1.13/16, 2 AF	Sliding T-Bar 770-S3 Extension Bar 200 mm 770-S4 Extension Bar 400 mm 770-S5	1	13900

770-S15.../771-S15...

SOCKET SET 3/4"

- MU=21 pcs., AU=20 pcs.
- in black metal storage case
- square drive according to DIN 3120, ISO 1174, with locking pin
- operation tools according to DIN 3122, ISO 3315

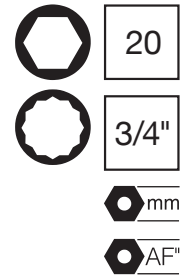

Code	Number	Ratchet	Sockets	Accessories	Pieces	Weight/g
0770580202000	770-S15 MU	Reversible Ratchet 770-S1U	Bi-Hexagon Sockets 770-SM 21, 22, 24, 27, 28, 30, 32, 34, 36, 38, 41, 42, 46, 47, 50 mm	Flexible Handle 770-S2 Sliding T-Bar 770-S3 Extension Bar 200 mm 770-S4 Extension Bar 400 mm 770-S5 Universal Joint 770-S6	1	17800
0771540152000	771-S15 MU	Reversible Ratchet 770-S1U	Hexagon Sockets 771-SM 21, 22, 24, 27, 28, 30, 32, 34, 36, 38, 41, 42, 46, 47, 50 mm	Flexible Handle 770-S2 Sliding T-Bar 770-S3 Extension Bar 200 mm 770-S4 Extension Bar 400 mm 770-S5 Universal Joint 770-S6	1	18000
0770580212000	770-S15 MZ	Push Through Ratchet 770-S1ZI	Bi-Hexagon Sockets 770-SM 21, 22, 24, 27, 28, 30, 32, 34, 36, 38, 41, 42, 46, 47, 50 mm	Flexible Handle 770-S2 Sliding T-Bar 770-S3 Extension Bar 200 mm 770-S4 Extension Bar 400 mm 770-S5 Universal Joint 770-S6	1	17200
0771540162000	771-S15 MZ	Push Through Ratchet 770-S1ZI	Hexagon Sockets 771-SM 21, 22, 24, 27, 28, 30, 32, 34, 36, 38, 41, 42, 46, 47, 50 mm	Flexible Handle 770-S2 Sliding T-Bar 770-S3 Extension Bar 200 mm 770-S4 Extension Bar 400 mm 770-S5 Universal Joint 770-S6	1	17800
0770580222000	770-S15 AU	Reversible Ratchet 770-S1U	Bi-Hexagon Sockets 770-SA 7/8, 15/16, 1, 1.1/16, 1.1/8, 1.1/4, 1.5/16, 1.3/8, 1.7/16, 1.1/2, 1.5/8, 1.11/16, 1.13/16, 1.7/8, 2 AF	Flexible Handle 770-S2 Sliding T-Bar 770-S3 Extension Bar 200 mm 770-S4 Extension Bar 400 mm 770-S5 Universal Joint 770-S6	1	17800
0770580232000	770-S15 AZ	Push Through Ratchet 770-S1ZI	Bi-Hexagon Sockets 770-SA 7/8, 15/16, 1, 1.1/16, 1.1/8, 1.1/4, 1.5/16, 1.3/8, 1.7/16, 1.1/2, 1.5/8, 1.11/16, 1.13/16, 1.7/8, 2 AF	Flexible Handle 770-S2 Sliding T-Bar 770-S3 Extension Bar 200 mm 770-S4 Extension Bar 400 mm 770-S5 Universal Joint 770-S6	1	17200

770-S22...

SOCKET SET 3/4"

- 32 pcs.
- in black metal storage case
- square drive according to DIN 3120, ISO 1174, with locking pin
- operation tools according to DIN 3122, ISO 3315

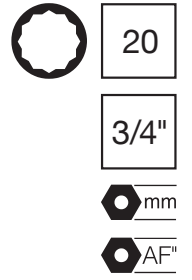

03

Code	Number	Ratchet	Sockets	Accessories	Pieces	Weight/g
0770580302000	770-S22 MAU	Reversible Ratchet 770-S1U	Bi-Hexagon Sockets 770-SM 19, 22, 24, 27, 30, 32, 36, 38, 41, 46, 50 mm 770-SA 3/4, 7/8, 15/16, 1, 1.1/16, 1.1/4, 1.7/16, 1.1/2, 1.5/8, 1.13/16, 2 AF	Flexible Handle 770-S2 Sliding T-Bar 770-S3 Extension Bar 100 mm 770-S15 Extension Bar 200 mm 770-S4 Extension Bar 400 mm 770-S5 Universal Joint 770-S6 Socket Converter, Male 1/2, Female 3/4 770-S9 Socket Converter, Male 1, Female 3/4 770-S11	1	24800
0770580312000	770-S22 MAZ	Push Through Ratchet 770-S1ZI	Bi-Hexagon Sockets 770-SM 19, 22, 24, 27, 30, 32, 36, 38, 41, 46, 50 mm 770-SA 3/4, 7/8, 15/16, 1, 1.1/16, 1.1/4, 1.7/16, 1.1/2, 1.5/8, 1.13/16, 2 AF	Flexible Handle 770-S2 Sliding T-Bar 770-S3 Extension Bar 100 mm 770-S15 Extension Bar 200 mm 770-S4 Extension Bar 400 mm 770-S5 Universal Joint 770-S6 Socket Converter, Male 1/2, Female 3/4 770-S9 Socket Converter, Male 1, Female 3/4 770-S11	1	21000

You will find the matching OMS-35/25 module on page no. 47



770-S24/26.../771-S24/26...

SOCKET SET 3/4"

- MU and MZ = 34 pcs.,
AU and AZ = 35 pcs.
- in black metal storage case
- square drive according to DIN 3120, ISO 1174,
with locking pin
- operation tools according to DIN 3122, ISO 3315

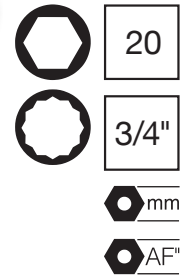

03

Code	Number	Ratchet	Sockets	Accessories	Pieces	Weight/g
0770580422000	770-S24/1 MU	Reversible Ratchet 770-S1U	Bi-Hexagon Sockets 770-SM 18, 19, 21, 22, 23, 24, 25, 26, 27, 28, 30, 32, 34, 36, 37, 38, 41, 42, 46, 47, 50, 54, 55, 60 mm	Flexible Handle 770-S2 Sliding T-Bar 770-S3 Extension Bar 100 mm 770-S15 Extension Bar 200 mm 770-S4 Extension Bar 400 mm 770-S5 Universal Joint 770-S6 Socket Converter, Male 1/2, Female 3/4 770-S9 Socket Converter, Male 1, Female 3/4 770-S11	1	25000
0771540282000	771-S24/1 MU	Reversible Ratchet 770-S1U	Hexagon Sockets 771-SM 18, 19, 21, 22, 23, 24, 25, 26, 27, 28, 30, 32, 34, 36, 37, 38, 41, 42, 46, 47, 50, 54, 55, 60 mm	Flexible Handle 770-S2 Sliding T-Bar 770-S3 Extension Bar 100 mm 770-S15 Extension Bar 200 mm 770-S4 Extension Bar 400 mm 770-S5 Universal Joint 770-S6 Socket Converter, Male 1/2, Female 3/4 770-S9 Socket Converter, Male 1, Female 3/4 770-S11	1	25000
0770580432000	770-S24/1 MZ	Push Through Ratchet 770-S1ZI	Bi-Hexagon Sockets 770-SM 18, 19, 21, 22, 23, 24, 25, 26, 27, 28, 30, 32, 34, 36, 37, 38, 41, 42, 46, 47, 50, 54, 55, 60 mm	Flexible Handle 770-S2 Sliding T-Bar 770-S3 Extension Bar 100 mm 770-S15 Extension Bar 200 mm 770-S4 Extension Bar 400 mm 770-S5 Universal Joint 770-S6 Socket Converter, Male 1/2, Female 3/4 770-S9 Socket Converter, Male 1, Female 3/4 770-S11	1	24500
0771540292000	771-S24/1 MZ	Push Through Ratchet 770-S1ZI	Hexagon Sockets 771-SM 18, 19, 21, 22, 23, 24, 25, 26, 27, 28, 30, 32, 34, 36, 37, 38, 41, 42, 46, 47, 50, 54, 55, 60 mm	Flexible Handle 770-S2 Sliding T-Bar 770-S3 Extension Bar 100 mm 770-S15 Extension Bar 200 mm 770-S4 Extension Bar 400 mm 770-S5 Universal Joint 770-S6 Socket Converter, Male 1/2, Female 3/4 770-S9 Socket Converter, Male 1, Female 3/4 770-S11	1	25200
0770580502000	770-S26 AU	Reversible Ratchet 770-S1U	Bi-Hexagon Sockets 770-SA 3/4, 13/16, 7/8, 15/16, 31/32, 1, 1.1/16, 1.1/8, 1.3/16, 1.1/4, 1.5/16, 1.3/8, 1.7/16, 1.1/2, 1.9/16, 1.5/8, 1.11/16, 1.3/4, 1.13/16, 1.7/8, 2, 2.1/16, 2.1/8, 2.3/16, 2.1/4, 2.3/8 AF	Flexible Handle 770-S2 Sliding T-Bar 770-S3 Extension Bar 100 mm 770-S15 Extension Bar 200 mm 770-S4 Extension Bar 400 mm 770-S5 Universal Joint 770-S6 Socket Converter, Male 1/2, Female 3/4 770-S9 Socket Converter, Male 1, Female 3/4 770-S11	1	27000
0770580512000	770-S26 AZ	Push Through Ratchet 770-S1ZI	Bi-Hexagon Sockets 770-SA 3/4, 13/16, 7/8, 15/16, 31/32, 1, 1.1/16, 1.1/8, 1.3/16, 1.1/4, 1.5/16, 1.3/8, 1.7/16, 1.1/2, 1.9/16, 1.5/8, 1.11/16, 1.3/4, 1.13/16, 1.7/8, 2, 2.1/16, 2.1/8, 2.3/16, 2.1/4, 2.3/8 AF	Flexible Handle 770-S2 Sliding T-Bar 770-S3 Extension Bar 100 mm 770-S15 Extension Bar 200 mm 770-S4 Extension Bar 400 mm 770-S5 Universal Joint 770-S6 Socket Converter, Male 1/2, Female 3/4 770-S9 Socket Converter, Male 1, Female 3/4 770-S11	1	26500

780-1
REVERSIBLE RATCHET 1", WITH TOMMY BAR

- forged gear wheel with 1" male- and 3/4" female square
- smallest possible swivel angle 11,25°
- matt chrome-plated
- ELORA-Chrome-Vanadium 31CrV3 / 1.2208
- male square drive according to DIN 3120-B 25, ISO 1174, with locking pin
- according to DIN 3122, ISO 3315

25
1"

Code	Number	l/mm	Pieces	Weight/g
0780000012000	780-1	660	1	3980
0780000012100	780-E1	Repair Kit	1	560

780M-...
SOCKET 1", BI-HEXAGON

- hot forged
- matt chrome-plated
- Chrome-Vanadium 31 CrV 3 / 1.2208
- female square according to DIN 3120-D 25, ISO 1174, with locking pin
- according to DIN 3124, ISO 2725-1

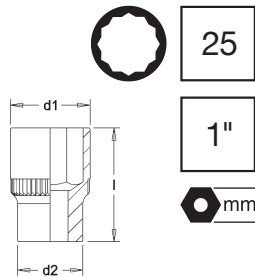

Code	Number	d1 mm	d2 mm	l/mm	Pieces	Weight/g
0780000361000	780-36	52,0	45,0	65,0	1	508
0780000381000	780-38 / 1.1/2	54,0	45,0	65,0	1	514
0780000411000	780-41 / 1.5/8	57,0	45,0	70,0	1	586
0780000461000	780-46 / 1.13/16	65,0	50,0	75,0	1	860
0780000501000	780-50	70,0	50,0	75,0	1	942
0780000551000	780-55	76,0	55,0	80,0	1	1178
0780000601000	780-60	82,0	55,0	84,0	1	1387
0780000651000	780-65	88,0	55,0	87,5	1	1525
0780000701000	780-70	94,0	60,0	93,0	1	1915
0780000751000	780-75	100,0	60,0	97,0	1	2100
0780000801000	780-80	105,0	60,0	103,0	1	2390

780A-...
SOCKET 1", BI-HEXAGON

- hot forged
- matt chrome-plated
- Chrome-Vanadium 31 CrV 3 / 1.2208
- female square according to DIN 3120-D 25, ISO 1174, with locking pin
- according to DIN 3124, ISO 2725-1

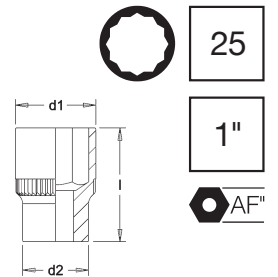

Code	Number	d1 mm	d2 mm	l/mm	Pieces	Weight/g
0780100211000	780A-1.7/16	52,0	45,0	65,0	1	504
0780000381000	780-38 / 1.1/2	54,0	45,0	65,0	1	514
0780000411000	780-41 / 1.5/8	57,0	45,0	70,0	1	586
0780000461000	780-46 / 1.13/16	65,0	50,0	75,0	1	860
0780100491000	780A-2	70,0	50,0	75,0	1	931
0780100551000	780A-2.3/8	82,0	55,0	84,0	1	1351
0780100581000	780A-2.9/16	88,0	55,0	90	1	1549
0780100591000	780A-2.5/8	90,0	55,0	90,0	1	1557
0780100601000	780A-2.3/4	94,0	60,0	93	1	1909
0780100631000	780A-3	102,0	60,0	103,0	1	2200
0780100641000	780A-3.1/8	105,0	60,0	103,0	1	2280

780-IN...

SCREWDRIVER SOCKET 1"

- for inside hexagon screws
- matt chrome-plated
- ELORA-Chrome-Vanadium 31CrV3 / 1.2208
- female square according to DIN 3120-D 25, ISO 1174
- according to DIN 7422

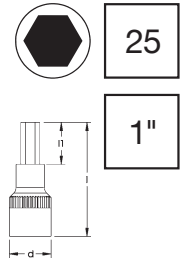

Code	Number	DIN 912 mm	d mm	l1 mm	l/mm	Pieces ☞	Weight/g ⚖
0780050171000	780-IN 17	M20-22	48,0	25,0	90	1	544
0780050191000	780-IN 19	M24-27	48,0	25,0	90	1	569
0780050221000	780-IN 22	M30	48,0	25,0	90	1	611
0780050241000	780-IN 24	M33	48,0	25,0	90	1	635

03

780-2

SLIDING T-BAR 1"

- matt chrome-plated
- ELORA-Chrome-Vanadium 31CrV3 / 1.2208
- male square according to DIN 3120-B 25, ISO 1174, with locking pin
- according to DIN 3122, ISO 3315

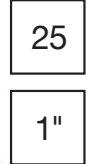

Code	Number	l/mm	Pieces ☞	Weight/g ⚖
0780000022000	780-2	640	1	3500

780-3/4

EXTENSION BAR 1"

- matt chrome-plated
- ELORA-Chrome-Vanadium 31 CrV 3 / 1.2208
- square drive according to DIN 3120, ISO 1174, with locking pin
- according to DIN 3123, ISO 3316



Code	Number	l/mm	Pieces ☞	Weight/g ⚖
0780000032000	780-3	200	1	1183
0780000042000	780-4	400	1	1990

780-7/770-S11

SOCKET CONVERTER 1"

- matt chrome-plated
- ELORA-Chrome-Vanadium 31CrV3 / 1.2208
- square drive according to DIN 3120, ISO 1174, with locking pin
- according to DIN 3123, ISO 3316

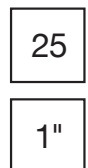

Code	Number	l/mm	□	○	Pieces ☞	Weight/g ⚖
0780100072000	780-7	70	3/4"	1	1	425
0770021102000	770-S11	55	1	3/4"	6	255

780-10...

SOCKET SET 1"

- 14 pcs.
- in black metal storage case
- square drive according to DIN 3120, ISO 1174, with locking pin
- operation tools according to DIN 3122, ISO 3315

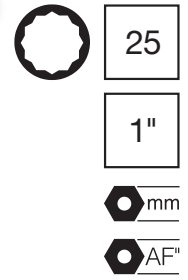

Code	Number	Ratchet	Sockets	Accessories	Pieces	Weight/g
0780501001000	780-10M	Reversible Ratchet 780-1	Bi-Hexagon Sockets 780- 36, 41, 46, 50, 55, 60, 65, 70, 75, 80 mm	Sliding T-Bar 780-2 Extension Bar 200 mm 780-3 Extension Bar 400 mm 780-4	1	33800

OTHER TYPES

765-...

RATCHET OPERATED PODGER SPANNER

- for scaffolding and constructional steel work
- reversible ratchets with two different sizes, with centering tips
- with lock hole Ø 5,2 mm
- smallest possible swivel angle 11,25°
- chrome-plated
- Chrome-Vanadium 31CrV3 / 1.2208



Code	Number	l/mm	Pieces	Weight/g
0765017191000	765-17x19	310	1	450
0765017211000	765-17x21	310	1	450
0765019221000	765-19x22	310	1	450
0765024301000	765-24x30	450	1	1280
0765027321000	765-27x32	450	1	1300
0765036411000	765-36x41	450	1	1320