

# 01

## ASSORTMENTS AND STORAGE UNITS



Roller Tool Cabinets, Tool Boxes, _____	Page 28
Accessories _____	
Tool Modules _____	Page 40
Tool Assortments _____	Page 67

**1220-L7**

**ROLLER TOOL CABINET SUPER CADDY**

01

- with 7 drawers
- solid metal sheet pattern, ELORA-yellow (RAL 1006)
- corrosion- and scratch-resistant powder-coating
- shelf space on the top made of ABS plastic with 7 storage compartments for small parts and rim on all sides
- 200 kg shelf load capacity due to strengthened top cover
- solid handlebar, mounting possible on both sides
- sides and back panel with Euro-Perforation 10 x 38 mm (hole square 10 x 10 mm, hole centre-hole centre 38 x38 mm) for mounting accessory hooks, trays, waste basket, can holder, paper roll holder, cable drum
- central locking system with cylinder lock and 2 keys
- loading capacity of each drawer 40 kg
- each drawer has a safety locking system and is 100% extractable
- drawer with ball bearing guide rails
- drawer internal measurements W 573 x D 410 mm
- drawers ELORA-black powder-coated (RAL 9005)
- can be individually divided with separators or equipped with ELORA-OMS modules
- total loading capacity 300 kg
- broad gauge running gear with 4 Ø 125 mm full rubber, smooth running castors, 2 swivel castors with double break function (tangential and axial)
- dividers for drawers separately available
- delivery without tools and accessories
- suitable assortments: WS and OMS
- **accessories can be found on [www.elora.de](http://www.elora.de)**

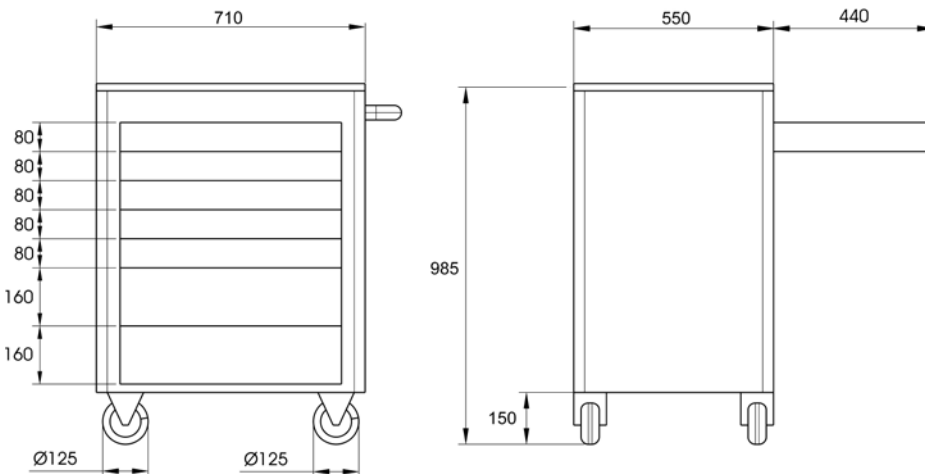

Code	Number	Height mm	Width mm	Depth mm	Loading Capacity kg	Pieces	Weight/g
1220000006000	1220-L7	985	710	550	450	1	78000

## 1220-L

### ROLLER TOOL CABINET SUPER CADDY 100

- with 7 drawers
- solid metal sheet pattern, ELORA-yellow (RAL 1006)
- corrosion- and scratch-resistant powder-coating
- storage surface made of PS (polystyrene), solvent-resistant, with integrated storage compartments
- very sturdy double-walled sheet steel construction
- with lateral perforated wall
- solid handlebar, mounting possible on both sides
- sides panel with Euro-Perforation
- central locking system with cylinder lock and 2 keys
- loading capacity of each drawer 45 kg
- 7 drawers with ball bearings and full-extension runners
- individual drawer locking over the whole ledge (one-hand operation)
- anti-tilt device (prevents several drawers from opening at the same time)
- drawer internal measurements W 573 x D 410 mm
- drawers ELORA-black powder-coated (RAL 9005)
- total loading capacity 450 kg
- broad gauge running gear with 4 Ø 125 mm full rubber, smooth running castors, 2 swivel castors with double break function (tangential and axial)
- delivery without tools and accessories
- suitable assortments: WS and OMS
- combinable with tool chest ELORA-No. 1221-L
- **other drawer types and special colours on request**
- **accessories can be found on [www.elora.de](http://www.elora.de)**



You will find the matching tool chest 1221-L on page 32

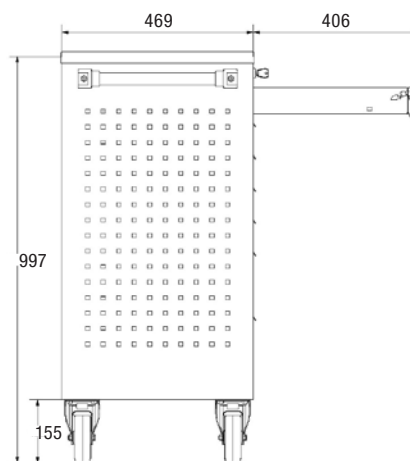
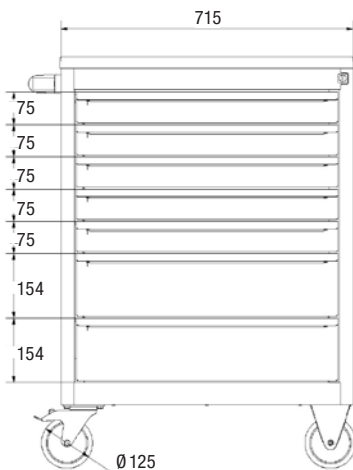

Code	Number	Height mm	Width mm	Depth mm	Loading Capacity kg	Pieces	Weight/g
1220000006100	1220-L	997	715	469	450	1	61500

## 1215-L

### ROLLER TOOL CABINET CADDY 100

- with 7 drawers
- solid metal sheet pattern, ELORA-yellow (RAL 1006)
- corrosion- and scratch-resistant powder-coating
- storage surface made of PS (polystyrene), solvent-resistant, with integrated storage compartments
- solid handlebar, mounting possible on left sides
- central locking system with cylinder lock and 2 keys
- loading capacity of each drawer 45 kg
- 7 drawers with ball bearings and full-extension runners
- individual drawer locking over the whole ledge (one-hand operation)
- drawer internal measurements W 573 x D 410 mm
- drawers ELORA-black powder-coated (RAL 9005)
- total loading capacity 450 kg
- broad gauge running gear with 4  $\varnothing$  125 mm full rubber, smooth running castors, 2 swivel castors with double break function (tangential and axial)
- delivery without tools and accessories
- suitable assortments: WS and OMS
- combinable with tool chest ELORA-No. 1221-L
- **other drawer types and special colours on request**
- **accessories can be found on [www.elora.de](http://www.elora.de)**



You will find the matching tool chest 1221-L on page 32

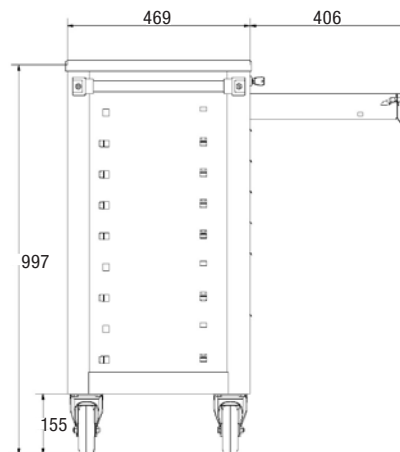
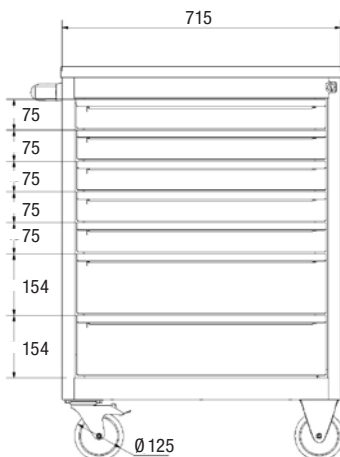

Code	Number	Height mm	Width mm	Depth mm	Loading Capacity kg	Pieces	Weight/g
1215000006100	1215-L	997	715	469	450	1	57000

## 1200-L

### SERVICECAR BUGGY 100

- solid metal sheet pattern, ELORA-yellow (RAL 1006)
- corrosion- and scratch-resistant powder-coating
- surface with rubber mat
- 2 swivel castors
- Shelf 460 x 705 mm
- total loading capacity 300 kg
- **ccessories can be found on [www.elora.de](http://www.elora.de)**

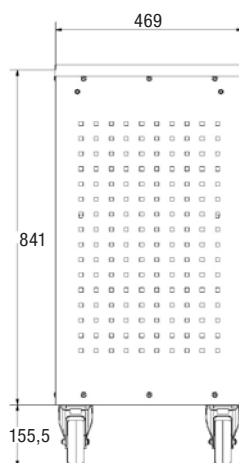
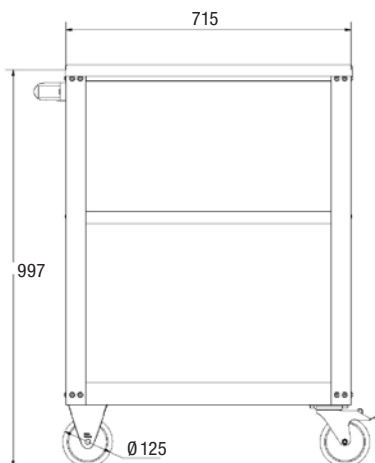

Code	Number	Height mm	Width mm	Depth mm	Loading Capacity kg	Pieces	Weight/g
1200520006100	1200-L	997	715	469	300	1	27500

## 1221-L

### TOOL CHEST

- 3 ball bearing mounted drawers
- individual drawer locking over the entire strip (one-hand operation)
- lateral central locking of all drawers with cylinder lock
- load capacity per drawer: 45 kg
- drawers: 3 x 75 mm
- internal drawer dimensions: 573 x 410 mm
- suitable for ELORA-Nr. 1220-L und 1215-L
- suitable assortments: OMS

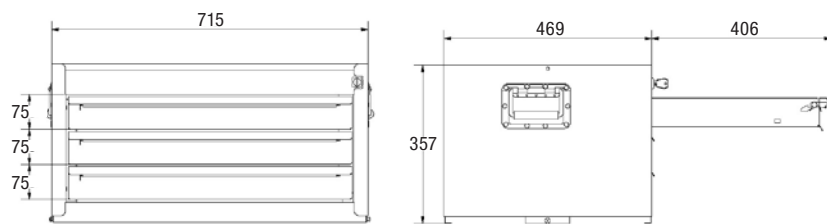

Code	Number	Height mm	Width mm	Depth mm	Loading Capacity per drawer kg	Pieces	Weight/g
1221000006100	1221-L	357	715	469	45	1	27000

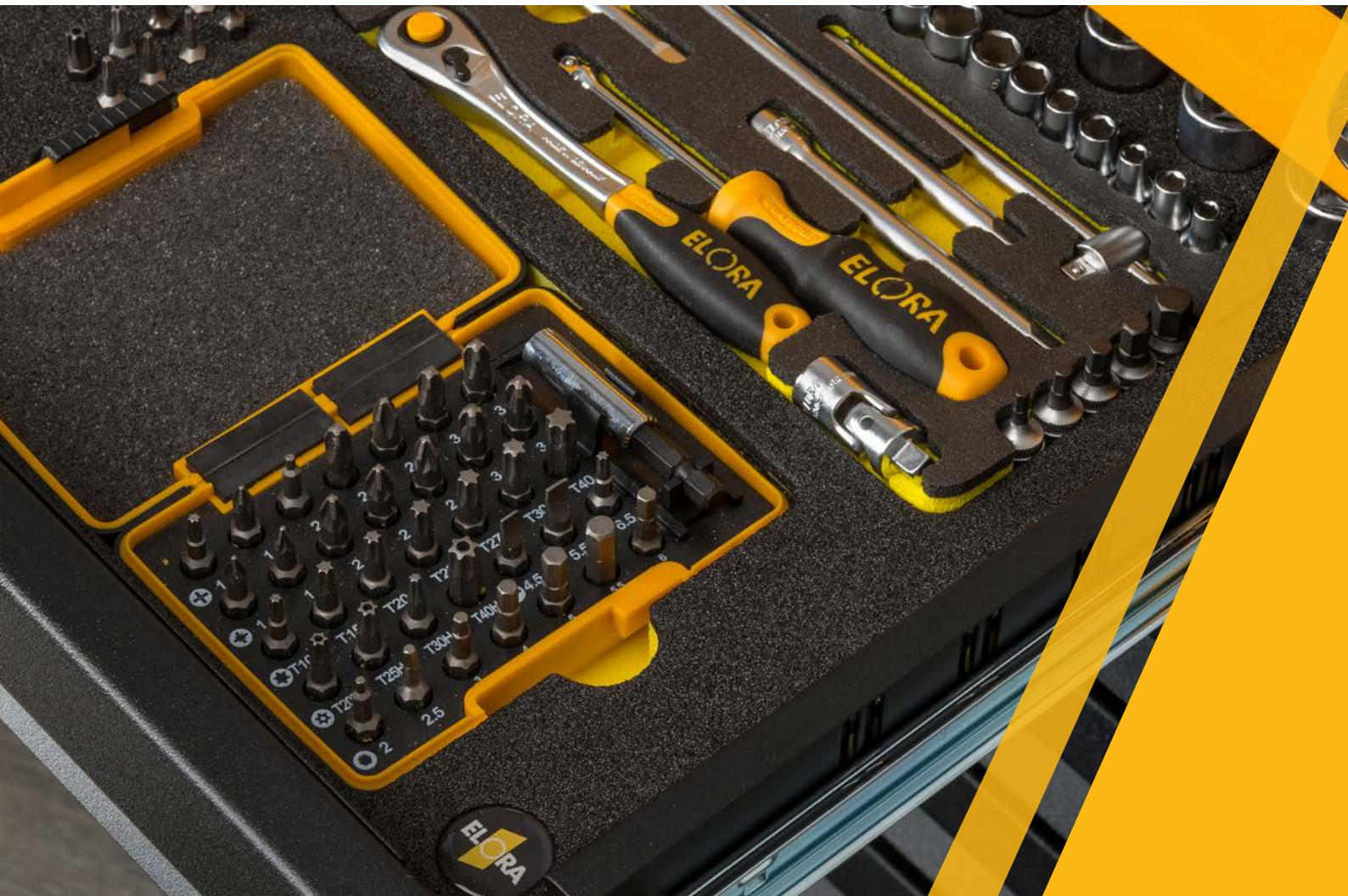

## 1210-L...

### ROLLER TOOL CABINET BUDDY

- 7 drawers
- solid metal sheet pattern, corrosion- and scratch-resistant powder-coating
- shelf space on the top made of ABS plastic with 5 storage compartments for small parts and rim on all sides
- solid handlebar, mounting possible on both sides
- up to 6 different accessories mountable in the recessed side wall e.g. storage foldable tray for small parts ELORA No. 1210-ES, screwdriver tray for 8 screwdrivers ELORA No. 1210-SD
- 2 can holder are included
- central locking system with 2 keys
- loading capacity of each drawer 20 kg respectively 30 kg for the two lower drawers
- each drawer has a safety locking system and is 100% extractable
- drawer with ball bearing guide rails
- drawer internal measurements W 570 x D 410 mm
- drawers ELORA-black powder-coated
- can be Individually equipped with ELORA OMS modules
- total loading capacity 300 kg
- broad gauge running gear with 4 Ø 125 mm full rubber, smooth running casters, 2 swivel castors with double break function (tangential and axial)
- delivery without tools and accessories
- suitable assortments: WS and OMS
- **accessories can be found on [www.elora.de](http://www.elora.de)**



1210-L7B

1210-L7R

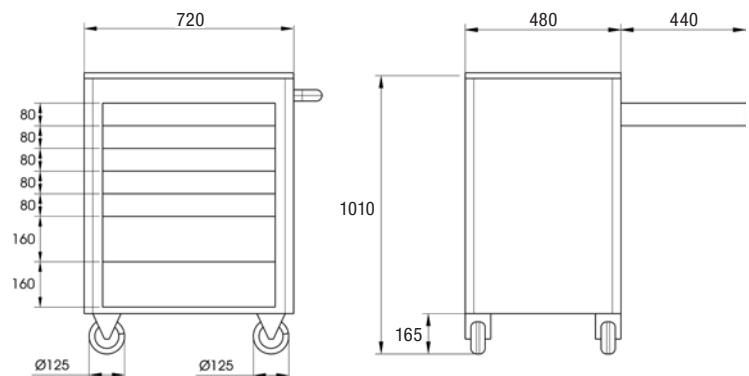

Code	Number	Height mm	Width mm	Depth mm	Loading Capacity kg	Pieces	Weight/g
121000006000	1210-L7	1010	720	480	300	1	67000
1210000016000	1210-L7R	1010	720	480	300	1	67000
1210000026000	1210-L7B	1010	720	480	300	1	67000

## 1811-L

### WHEELED WORK BENCH

- sturdy double-walled sheet steel construction
- scratch resistant, powder coated, ELORA-yellow (RAL 1006), door/drawers black (RAL 9006)
- Storage surface made of PS (polystyrene), solvent-resistant, with integrated storage compartments
- 7 drawers with ball bearings and full-extension runners
- individual drawer locking over the whole ledge (one-hand operation)
- drawer internal measurements W 573 x D 410 mm
- drawers ELORA-black powder-coated (RAL 9005)
- central locking system with cylinder lock and 2 keys
- anti-tilt device (prevents several drawers from opening at the same time)
- load capacity per drawer: 45 kg
- door side with one shelf
- stable handle
- 2 fixed and 2 braked swivel castors
- total load capacity 450 kg
- suitable assortments: all OMS-Modules

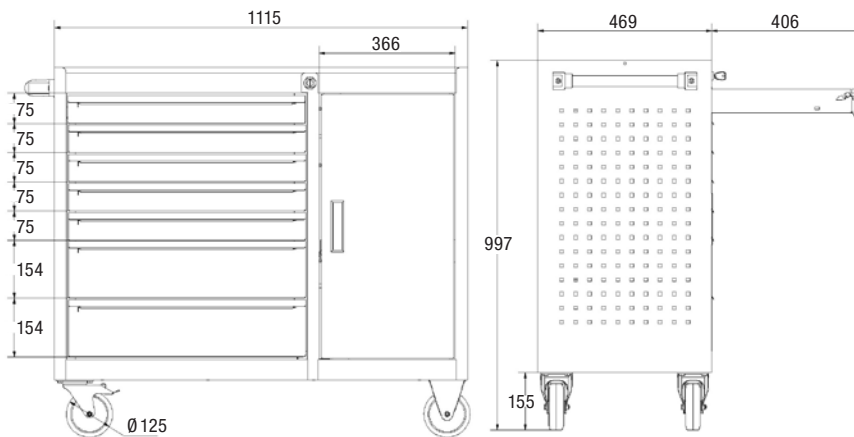

Code	Number	Width mm	Height mm	Depth mm	Pieces	Weight/g
1811500006100	1811-L	1115	997	469	1	80000

## 1200-RM 18

### ANTI SLIP MAT

- for drawers in tool cabinets and work benches
- Length: 2m



Code	Number	Width mm	Pieces	Weight/g
1200004752000	1200-RM 18	475	1	650



## 1227-L

### CABINET

- completely welded steel sheet construction
- 2 doors, with 4 height-adjustable shelves
- load capacity 50 kg per shelf
- doors strengthened and 3-point safety lock
- rotary handle with cylinder lock
- powder coated, ELORA-yellow (RAL 1006) doors black (RAL 9005)



Code	Number	Width mm	Height mm	Depth mm	Pieces	Weight/g
1227000006000	1227-L	950	1900	500	1	83000

## 1100L

### TOOL CABINET

- 2 doors, with 2 drawers
- lockable with cylinder lock
- powder coated, ELORA-yellow (RAL 1006), doors black (RAL 9005)
- stable steel sheet version
- suitable assortments: all OMS-Modules



Code	Number	Width mm	Height mm	Depth mm	suitable assortments	Pieces	Weight/g
1100520001000	1100L	690	1000	290	WS-1 to 5	1	26000

### 1382-L1

#### PLASTIC TOOL CASE

- organisers for small parts integrated in the lid
- removeable tool tray
- solid single hand handle
- Polypropylene



Code	Number	Width mm	Height mm	Depth mm	Pieces	Weight/g
1382000000001	1382-L1	400	190	220	1	940

### 1382-L2

#### PLASTIC TOOL CASE

- organisers for small parts integrated in the lid
- internal tray with handle, complete with bit holder and measuring scale (cm/inch)
- solid single hand handle
- Polypropylene



Code	Number	Width mm	Height mm	Depth mm	Pieces	Weight/g
1382000000002	1382-L2	510	240	240	1	1550

### 1383-L

#### MULTI PURPOSE CASE

- ergonomic bow-type handle made of aluminium
- 2 large compartments offer storage space for tools and implements
- compartments with handy cm/inch scale
- Polypropylene



Code	Number	Width mm	Height mm	Depth mm	Pieces	Weight/g
1383000000000	1383-L	395	215	290	1	575

## 1815

### WORK TABLE, FOLDABLE

- ▶ for mobile use, foldable to measurement H 140, W 1000, D 700 mm
- ▶ strong, multiple glued beech wood working surface
- ▶ rack made of steel tube, scratch-resistant ELORA yellow lacquered



Code	Number	Height mm	Width mm	Depth mm	Loading Capacity kg	Pieces	Weight/g
1815010001000	1815	820	1000	700	500	1	26000

## 800L/810L

### CANTILEVER TOOL BOX WITH 5 TRAYS

- ▶ blue lacquered, to be locked with padlock ELORA-No. 256
- ▶ heavy gauge sheet steel



Code+	Number	Width mm	Height mm	Depth mm	suitable assortments	Pieces	Weight/g
0800520031000	800L	430	200	200	WS-1, 9	1	4300
0810510031000	810L	530	200	200	WS-1, 2, 3, 4, 8, 9, 10	1	5200

## 803L/813L

### CANTILEVER TOOL BOX WITH 3 TRAYS

- ▶ blue lacquered, to be locked with padlock ELORA-No. 256
- ▶ heavy gauge sheet steel



Code	Number	Width mm	Height mm	Depth mm	suitable assortments	Pieces	Weight/g
0803510036000	803L	430	150	195	WS-1, 9	1	3300
0813510036000	813L	530	150	195	WS-1, 9	1	3600

## 256

### PADLOCK

- ▶ for cantilever tool box ELORA-No.800L, 803L, 810L and 813L
- ▶ with steel bow 29 mm, incl. 2 keys
- ▶ Brass



Code	Number	Width mm	Pieces	Weight/g
0256000000000	256	43,8	1	80

## 1380-L

### HARD PROTECTIVE CASE

- variable dividable floor shell
- removable cover board with 15 tool pockets
- removable tool board with 22 tool pockets on the front and back
- document compartment in the lid (A4 format)
- 2 lockable clip locks made of metal
- hinge cover
- robust aluminium frame with protection for the sharp edges
- trolley case made of dent proof black ABS material
- **delivery without tools**



Code	Number	Internal measurements WxDxH mm	External measurements WxDxH mm	max. bearing load	suitable assortments	Pieces	Weight/g
1380000000000	1380-L	460x315x169	490x365x188	25	WS-4, 6, 8, 9, 10	1	5000

## 1381-L

### HARD PROTECTIVE TROLLEY CASE

- mobile case with telescopic handle and 2 free running rollers
- variable dividable floor shell
- removable cover board with 15 tool pockets
- removable tool board with 23 tool pockets on the front and back
- document compartment in the lid (A4 format)
- 2 lockable clip locks made of metal and additional combination lock
- hinge cover
- robust aluminium frame with protection for the sharp edges
- trolley case made of dent proof black ABS material
- **delivery without tools**



Code	Number	Internal measurements WxDxH mm	External measurements WxDxH mm	max. bearing load	Volume l	suitable assortments	Pieces	Weight/g
1381000000000	1381-L	485x375x200	515x440x225	30	36	WS-4, 6, 8, 9, 10	1	6280

## 1386-L

### TECHNICIANS NOTEBOOK TOOL BAG

- padded lap-top compartment (17") and additional document compartment (A4 format)
- removable tool board with 8 pockets on the front and 2 rows elastic hangers on the back
- 2 small and 5 big pockets on the inside
- key ring holder
- front side 90 ° foldable
- on each side big attached pocket with hook and loop fastener
- splash proofed bottom
- adjustable strap with shoulder cushion quick fastener
- handle double fixable
- made of tear-proofed black nylon
- **delivery without tools and accessories**



01

Code	Number	Internal measurements WxDxH mm	External measurements WxDxH mm	max. bearing load	Pieces	Weight/g
1386000000000	1386-L	440x320x180	450x340x200	12	1	2380

## 1385-L

### INSTALLATION TOOL BAG

- robust tool bag with moisture repellent bottom
- solid metal handle with padded grip
- removable cover and padded carrying strap
- outside 5 compartments with hook and loop fastener, fixation for water level
- inside 10 pockets and 8 hangers
- made of tear-proofed durable black nylon
- **delivery without tools**



Code	Number	Internal measurements WxDxH mm	External measurements WxDxH mm	max. bearing load	suitable assortments	Pieces	Weight/g
1385000000000	1385-L	400x190x240	450x250x270	12	WS-6, 9, 10	1	2820

**OMS-47**
**MODULE-AUTOMOTIVE-TIRE AND BRAKE ASSORTMENT**

- for ELORA-roller tool cabinets
- black, with yellow signal colour
- oil and grease resistant
- chemical resistant
- Width: 41,0 cm, Depth: 57,3 cm
- hard foam insert

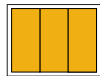
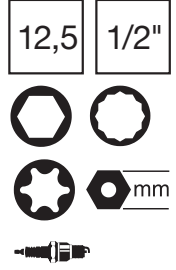

Code	Number	Contents	Pieces	Weight/g
0000414701000	OMS-47	Combination Spanner with Ring Ratchet, reversible 204-J 8, 10, 12, 13, 17, 19 mm Double-Ended Ring Spanner for outside TORX®-Screws 119TXE- 6×8, 10×12, 14×18, 20×24 mm Open Ring Spanner 121-10×11 mm Adjustable Wrench 60-12MB Spark Plug Socket 1/2" 771-LTZ 16, 18, 20,8 mm Socket Converter 770-L14, 1/2"    3/8" Impact Socket 1/2" 790LTP-17, 19, 21 mm Torque Wrench with Vernier Scale 2179-60   10-60 Nm, 2179-200   40-200 Nm Engineer's Hammer, German Pattern 1665-500 Feeler Gauge 188-13M Tyre Lever 165-300, 165-500 Brush for Brake Service 293BS Seal Flat Scraper 290-1	1	6565
0000414707000	OMS-47L	empty module	1	180

**OMS-50**
**MODULE-SPANNER SET**

- for ELORA-roller tool cabinets
- black, with yellow signal colour
- oil and grease resistant
- chemical resistant
- Width: 41,0 cm, Depth: 57,3 cm
- hard foam insert

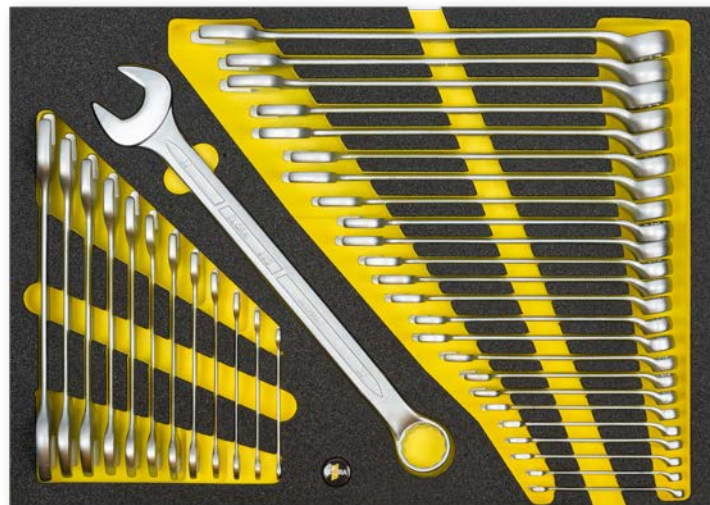

Code	Number	Contents	Pieces	Weight/g
0000415001000	OMS-50	Combination Spanners, cranked 205- 6, 7, 8, 9, 10, 11, 12, 13, 14, 15, 16, 17, 18, 19, 20, 21, 22, 23, 24, 25, 26, 27, 28, 30, 32 mm Double Open-Ended Spanners DIN 3110 100- 6×7, 8×9, 10×11, 12×13, 14×15, 16×17, 18×19, 20×22, 21×23, 24×27, 25×28, 30×32 mm	1	8010
0000415007000	OMS-50L	empty module	1	160

## OMS-15

### MODULE-DOUBLE OPEN ENDED SPANNER

- for ELORA-roller tool cabinets
- black, with yellow signal colour
- oil and grease resistant
- chemical resistant
- Width: 41,0 cm, Depth: 18,9 cm
- hard foam insert

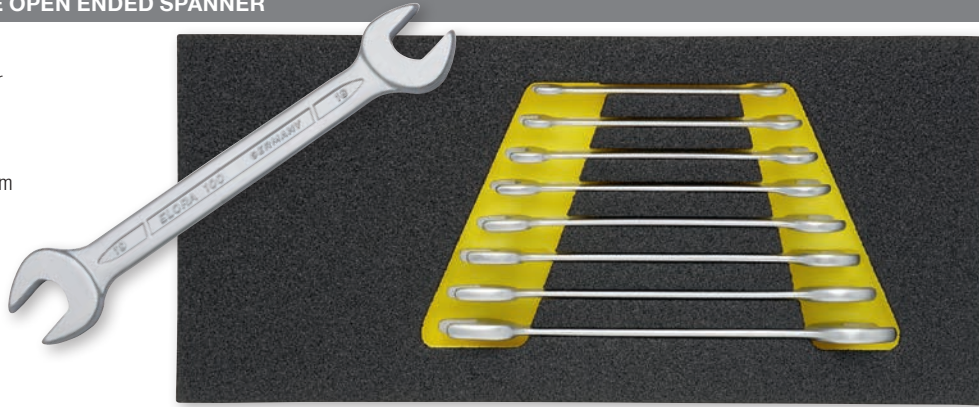

mm



Code	Number	Contents	Pieces	Weight/g
0000411501000	OMS-15	Double Open-Ended Spanners DIN 3110 100- 6×7, 8×9, 10×11, 12×13, 14×15, 16×17, 18×19, 20×22 mm	1	900
0000411507000	OMS-15L	empty module	1	80

## OMS-1

### MODULE-COMBINATION SPANNERS, CRANKED

- for ELORA-roller tool cabinets
- black, with yellow signal colour
- oil and grease resistant
- chemical resistant
- Width: 41,0 cm, Depth: 18,9 cm
- hard foam insert

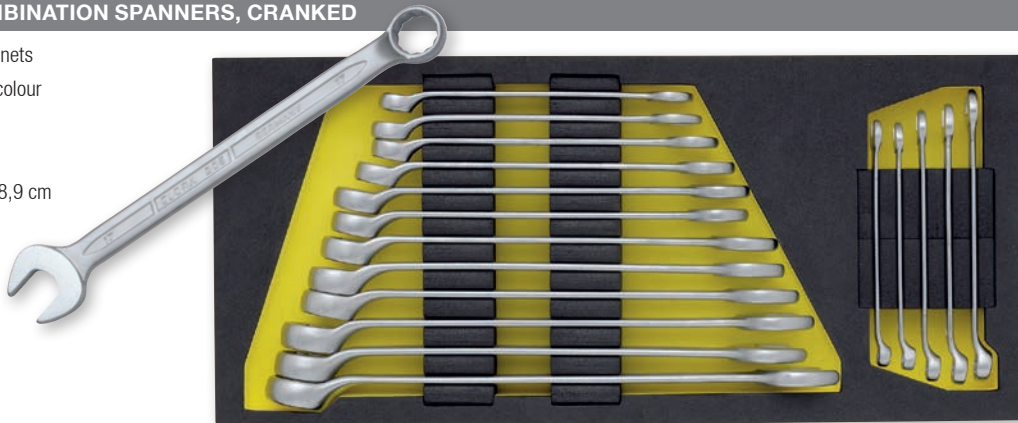

  
 mm

Code	Number	Contents	Pieces	Weight/g
0000410101000	OMS-1	Combination Spanners, cranked 205- 6, 7, 8, 9, 10, 11, 12, 13, 14, 15, 16, 17, 18, 19, 20, 21, 22 mm	1	1990
0000410107000	OMS-1L	empty module	1	70

## OMS-51

### MODULE-SPANNER SET

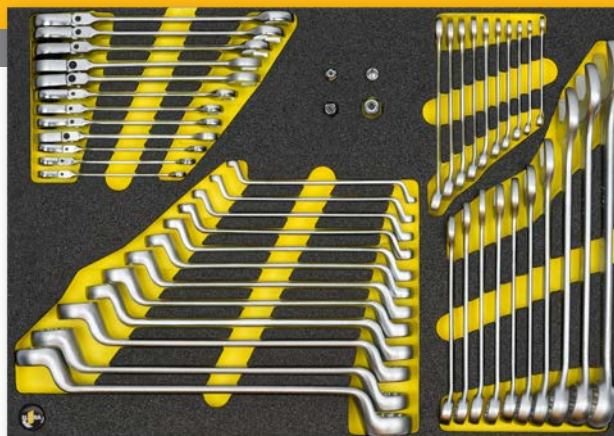
- for ELORA-roller tool cabinets
- black, with yellow signal colour
- oil and grease resistant
- chemical resistant
- Width: 41,0 cm, Depth: 57,3 cm
- hard foam insert



  
 mm

Code	Number	Contents	Pieces	Weight/g
0000415101000	OMS-51	Combination Spanners, bent 203- 6, 7, 8, 9, 10, 11, 12, 13, 14, 15, 16, 17, 18, 19, 21, 22, 24, 27, 30, 32, mm Double-Ended Ring Spanners, DIN 838 110- 6×7, 8×9, 10×11, 12×13, 14×15, 16×17, 18×19, 20×22, 21×23, 24×27, 25×28, 30×32 mm Combination Spanner with Joint-Ring Ratchet 204R- 8, 9, 10, 11, 12, 13, 14, 15, 16, 17, 18, 19 mm Adapter Drives for bits 1/4", 3/8", 1/2" und 1/4" Bit-Adaptor 118- 1, 2, 3, 4	1	8100
0000415107000	OMS-51L	empty module	1	160

### OMS-9

#### MODULE-COMBINATION SPANNER, BENT

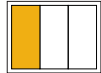
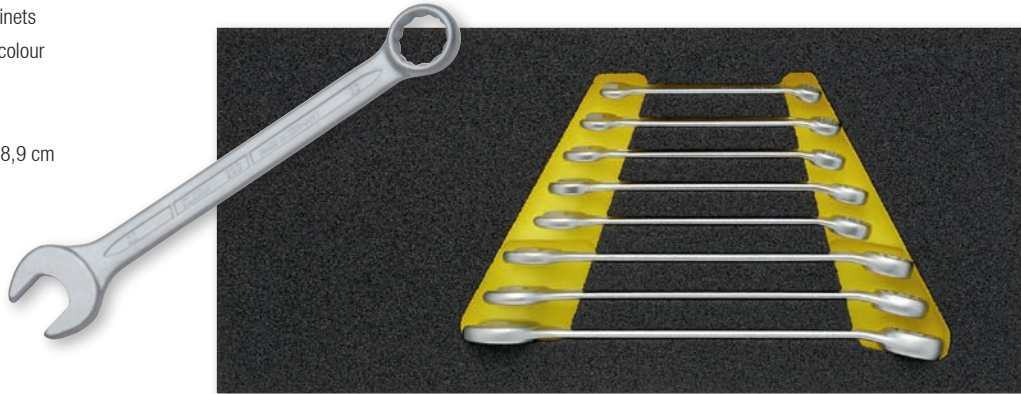
- for ELORA-roller tool cabinets
- black, with yellow signal colour
- oil and grease resistant
- chemical resistant
- Width: 41,0 cm, Depth: 18,9 cm
- hard foam insert



Code	Number	Contents	Pieces	Weight/g
0000410901000	OMS-9	Combination Spanners, bent 203- 8, 10, 11, 13, 14, 17, 19, 22 mm	1	690
0000410907000	OMS-9L	empty module	1	80

### OMS-22

#### MODULE-COMBINATION SPANNER, BENT

- for ELORA-roller tool cabinets
- black, with yellow signal colour
- oil and grease resistant
- chemical resistant
- Width: 41,0 cm, Depth: 18,9 cm
- hard foam insert

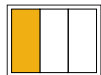
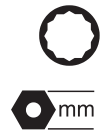

Code	Number	Contents	Pieces	Weight/g
0000412201000	OMS-22	Combination Spanners, bent 203- 24, 27, 30, 32 mm	1	1820
0000412207000	OMS-22L	empty module	1	60

### OMS-30

#### MODULE-COMBINATION SPANNER WITH RING RATCHET

- for ELORA-roller tool cabinets
- black, with yellow signal colour
- oil and grease resistant
- chemical resistant
- Width: 41,0 cm, Depth: 18,9 cm
- hard foam insert

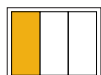

Code	Number	Contents	Pieces	Weight/g
0000413001000	OMS-30	Combination Spanners with Ring Ratchet 204- 8, 9, 10, 12, 13, 14, 17, 19 mm Adapter Drives for bits für 1/4", 3/8", 1/2" und 1/4" Bit-Adaptor 118- 1, 2, 3, 4	1	933
0000413007000	OMS-30L	empty module	1	80



## OMS-33

### MODULE-COMBINATION SPANNER WITH RING RATCHET, REVERSIBLE

- for ELORA-roller tool cabinets
- black, with yellow signal colour
- oil and grease resistant
- chemical resistant
- Width: 41,0 cm, Depth: 18,9 cm
- hard foam insert



Code	Number	Contents	Pieces	Weight/g
0000413301000	OMS-33	Combination Spanner with Ring Ratchet, reversible 204J- 8, 9, 10, 12, 13, 14, 17, 19 mm Adapter Drives for bits für 1/4", 3/8", 1/2" und 1/4" Bit-Adaptor 118- 1, 2, 3, 4	1	998
0000413307000	OMS-33L	empty module	1	80

## OMS-32

### MODULE-COMBINATION SPANNER WITH JOINT-RING RATCHET

- for ELORA-roller tool cabinets
- black, with yellow signal colour
- oil and grease resistant
- chemical resistant
- Width: 41,0 cm, Depth: 18,9 cm
- hard foam insert

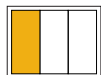

Code	Number	Contents	Pieces	Weight/g
0000413201000	OMS-32	Combination Spanner with Joint-Ring Ratchet 204R- 8, 9, 10, 12, 13, 14, 17, 19 mm Adapter Drives for bits für 1/4", 3/8", 1/2" und 1/4" Bit-Adaptor 118- 1, 2, 3, 4	1	980
0000413207000	OMS-32L	empty module	1	80

## OMS-19

### MODULE-DOUBLE-ENDED RING SPANNER

- for ELORA-roller tool cabinets
- black, with yellow signal colour
- oil and grease resistant
- chemical resistant
- Width: 41,0 cm, Depth: 18,9 cm
- hard foam insert

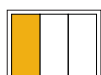
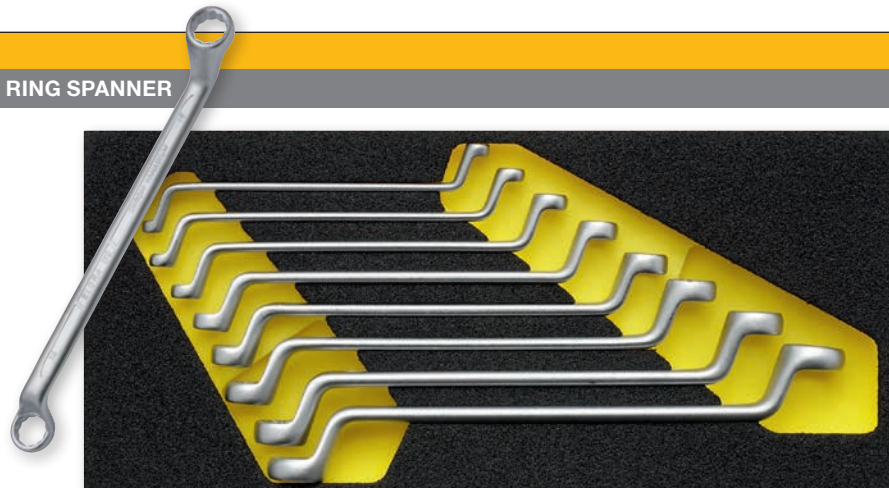

Code	Number	Contents	Pieces	Weight/g
0000411901000	OMS-19	Double-Ended Ring Spanners, DIN 838 110- 6x7, 8x9, 10x11, 12x13, 14x15, 16x17, 18x19, 20x22 mm	1	1350
0000411907000	OMS-19L	empty module	1	70

## OMS-28

### MODULE-RATCHET RING SPANNER

- for ELORA-roller tool cabinets
- black, with yellow signal colour
- oil and grease resistant
- chemical resistant
- Width: 41,0 cm, Depth: 18,9 cm
- hard foam insert

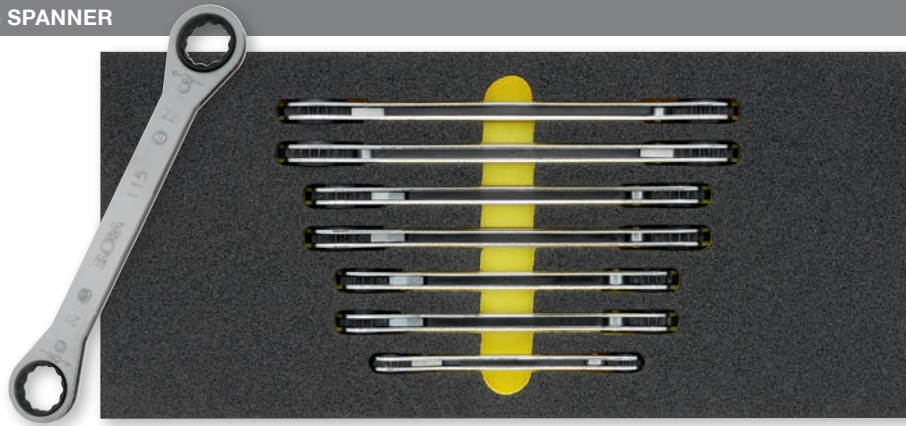

Code	Number	Contents	Pieces	Weight/g
0000412801000	OMS-28	Ratchet Ring Spanners, straight 115 - 8x9, 10x11, 12x13, 14x15, 16x17, 18x19, 21x22 mm	1	1330
0000412807000	OMS-28L	empty module	1	80

## OMS-29

### MODULE-RATCHET RING SPANNERS, BENT

- for ELORA-roller tool cabinets
- black, with yellow signal colour
- oil and grease resistant
- chemical resistant
- Width: 41,0 cm, Depth: 18,9 cm
- hard foam insert

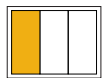
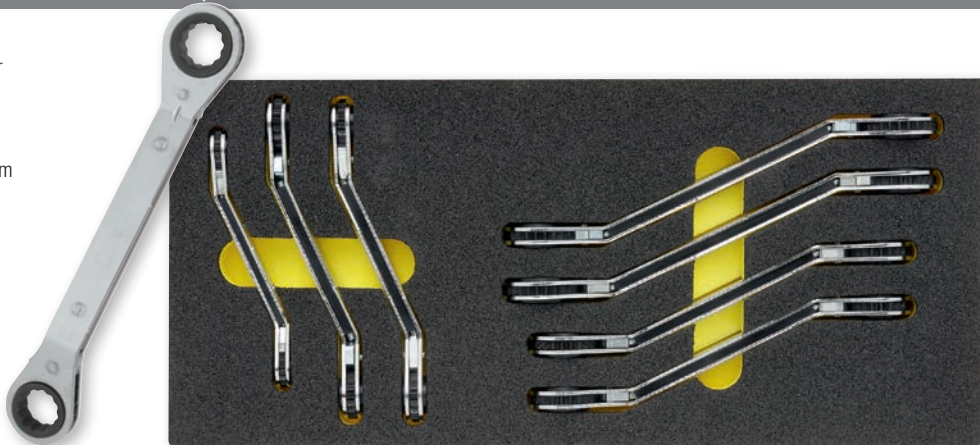

Code	Number	Contents	Pieces	Weight/g
0000412901000	OMS-29	Ratchet Ring Spanners, bent 115G - 8x9, 10x11, 12x13, 14x15, 16x17, 18x19, 21x22 mm	1	1340
0000412907000	OMS-29L	empty module	1	80

## OMS-31

### MODULE-FLARE NUT OPEN ENDED RING SPANNER

- for ELORA-roller tool cabinets
- black, with yellow signal colour
- oil and grease resistant
- chemical resistant
- Width: 41,0 cm, Depth: 18,9 cm
- hard foam insert

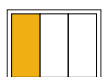
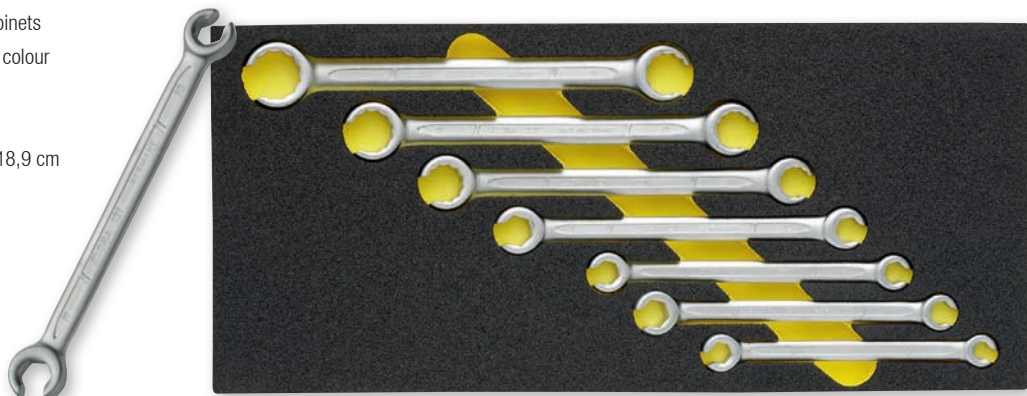

Code	Number	Contents	Pieces	Weight/g
0000413101000	OMS-31	Ended Ring Spanners for flare nuts 121 - 8x10, 10x11, 11x13, 12x14, 14x17, 17x19, 19x22 mm	1	850
0000413107000	OMS-31L	empty module	1	80

## OMS-46

### MODULE-SOCKET SET 1/4" AND 1/2"

- ▶ for ELORA-roller tool cabinets
- ▶ black, with yellow signal colour
- ▶ oil and grease resistant
- ▶ chemical resistant
- ▶ Width: 41,0 cm, Depth: 57,3 cm
- ▶ hard foam insert

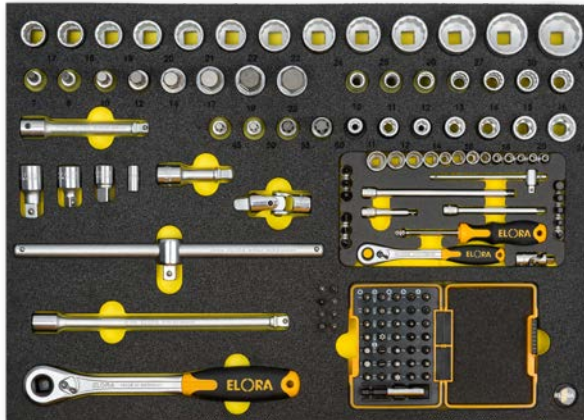

6,3 12,5

1/4" 1/2"

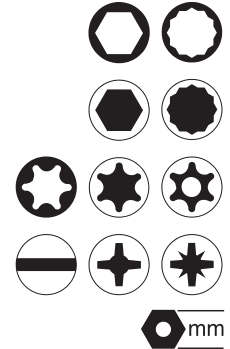

mm

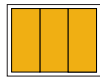

Code	Number	Contents	Pieces	Weight/g
0000414601000	OMS-46	1440-MU Socket Set 1/4", 30 pcs. ○ ● ⊖ ⊕ Bitbox 1/4", 36 pcs. ⊖ ⊕ ⊕ ⊕ ⊕ ⊕ Screwdriver Bit 1/4" for Inside TORX® Screws ☆ 3050-TX 6, 7, 8, TX 9, TX 10 Screwdriver Bit 1/4" for Inside TORX® Safety Screws ☆ 3070-TTX 10, 15, 27 Socket Converter 1/4" 1450-16, 1/4" ○   1/4" ○ Bihexagon Sockets 1/2" ○ 770-LM 10, 11, 12, 13, 14, 15, 16, 17, 18, 19, 20, 21, 22, 23, 24, 25, 26, 27, 30, 32 mm Reversible Ratchet 1/2" 770-L1D Sliding T-Bar 1/2" 770-L3	1	6540
0000414607000	OMS-46L	empty module	1	180

## OMS-52

### MODULE-SOCKET SET, DEEP 1/4" AND 1/2"

- ▶ for ELORA-roller tool cabinets
- ▶ black, with yellow signal colour
- ▶ oil and grease resistant
- ▶ chemical resistant
- ▶ Width: 41,0 cm, Depth: 57,3 cm
- ▶ hard foam insert

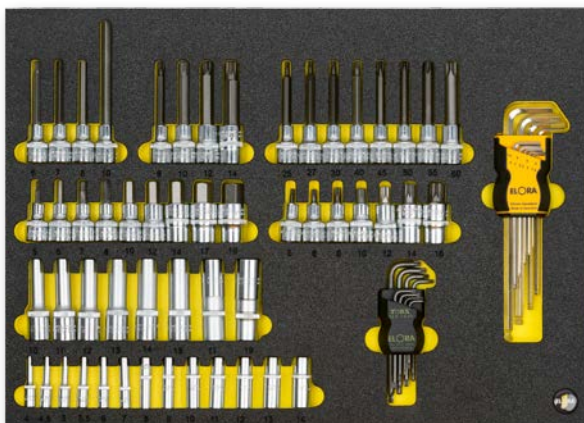

6,3 12,5

1/4" 1/2"

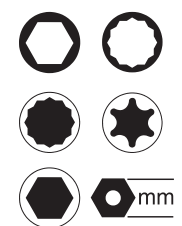

mm

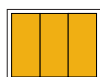

Code	Number	Contents	Pieces	Weight/g
0000415201000	OMS-52	Hexagon Sockets, extra deep 1/4" ○ 1455-T 4, 4,5, 5, 5,5, 6, 7, 8, 9, 10, 11, 12, 13, 14 mm Hexagon Sockets, extra deep 1/2" ○ 771-LT 10, 11, 12, 13, 14, 15, 17, 19 mm Screwdriver Sockets 1/2" for inside Hexagon Screws ● 3210-IN 5, IN 6, IN 7, IN 8, IN 10, IN 12, IN 14, IN 17, IN 19 Screwdriver Sockets 1/2", long for inside Hexagon Screws ● 3210-INL 6x100, INL 7x100, INL 8x100, INL 10x140 Screwdriver Sockets 1/2", long for inside-TORX®-Screws ☆ 3245-TXL 25, TXL 27, TXL 30, TXL 40, TXL 45, TXL 50, TXL 55, TXL 60	1	5370
0000415207000	OMS-52L	empty module	1	160

## OMS-2

### MODULE-SOCKET SET 1/4"

- for ELORA-roller tool cabinets
- black, with yellow signal colour
- oil and grease resistant
- chemical resistant
- Width: 41,0 cm, Depth: 18,9 cm
- hard foam insert



6,3 1/4"

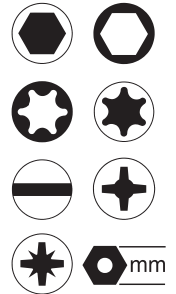

Code	Number	Contents		Pieces	Weight/g
0000410201000	OMS-2	Hexagon Sockets 1/4" ○ 1455-4, 4,5, 5, 5,5, 6, 7, 8, 9, 10,11, 12, 13, 14 mm Screwdriver Sockets for plain slotted screws ⊖ 1455-IS 0,8x4, 1,0x5,5, 1,6x8,0 mm Screwdriver Sockets for cross slotted screws ⊕ 1455-PH 1, PH 2, PH 3, PH 4 Screwdriver Sockets for cross slotted screws ⊕ 1455-PZ 1, PZ 2 Screwdriver Sockets for inside hexagon screws ● 1455-IN 3, 4, 5, 6, 8 mm Sockets for outside TORX® screws ⊕ 1455-TXE 4, 5, 6, 7, 8, 10,11	Screwdriver Sockets for inside TORX® screws ⊕ 3243-TX 8, 10, 15, 20, 25, 27, 30,40 Reversible Ratchets 1450-1D Spinner Handle 1450-3 Sliding T-Bar 1450-4 Universal Joint 1450-8 Extension Bar 50 mm 1450-11 Extension Bar 150 mm 1450-12 Socket Converter 1/4" 1450-15, 3/8" ■   1/4" ○ 159SKU Ball End Hexagon Key Set, extra long, 1,5-10 mm ●	1	1480
0000410207000	OSM-2L	empty module		1	80

## OMS-49

### MODULE-SOCKET SET 3/8"

- for ELORA-roller tool cabinets
- black, with yellow signal colour
- oil and grease resistant
- chemical resistant
- Width: 41,0 cm, Depth: 37,7 cm
- hard foam insert

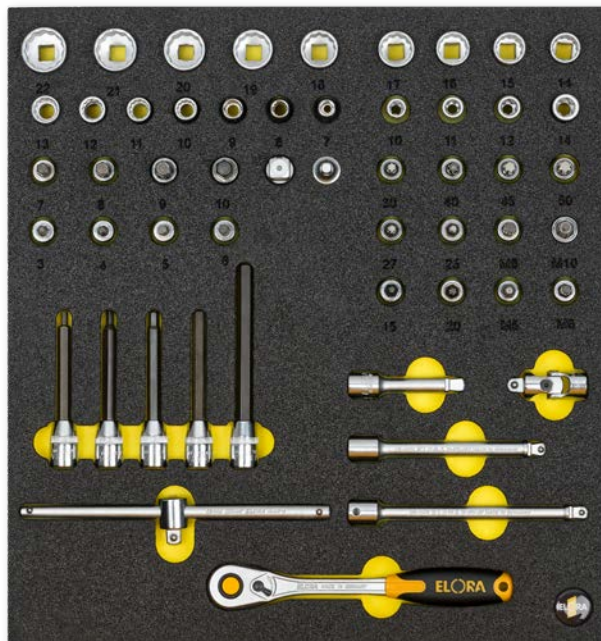

10 3/8"

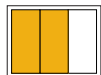
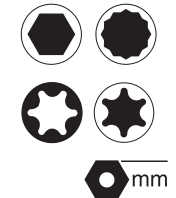

Code	Number	Contents		Pieces	Weight/g
0000414901000	OMS-49	Bi-Hexagon Sockets ○ 870- 7, 8, 9, 10, 11, 12, 13, 14, 15, 16, 17, 18, 19, 20, 21, 22 mm Screwdriver Sockets ● 3510-IN 3, 4, 5, 6, 7, 8, 9, 10 Screwdriver Sockets long for inside hexagon screws ● 3510-INL 4x100, 5x100, 6x100, 8x100, 10x130 Screwdriver Sockets for inside-TORX® screws ⊕ 3244-TX 15, 20, 25, 27, 30, 40, 45, 50 Screwdriver Sockets for inside multi-point B & S and XZN screws ● 3530-XZN 5, 6, 8, 10	Screwdriver Sockets for Outside-TORX® screws ⊕ 870-TXE 10, 11, 12, 14 Reversible Ratchet 870-1D Sliding T-Bar 870-8 Universal Joint 870-9 Extension Bar, swivelling 50 mm 870-3V Extension Bar, swivelling 125 mm 870-35V Extension Bar, swivelling 150 mm 870-4V Socket Converter 870-10, 1/4" ■   3/8" ○ Socket Converter 770-L14, 1/2" ■   3/8" ○	1	3165
0000414907000	OSM-49L	empty module		1	160

### OMS-34/21

#### MODULE - SOCKET SET 3/8"

- for ELORA-roller tool cabinets
- black, with yellow signal colour
- oil and grease resistant
- chemical resistant
- Width: 41,0 cm, Depth: 18,9 cm
- hard foam insert

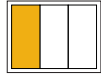
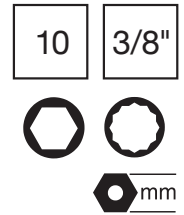

Code	Number	Contents	Pieces	Weight/g
0000413401000	OMS-34	Bi-Hexagon Sockets 870- 7, 8, 9, 10, 11, 12, 13, 14, 15, 16, 17, 18, 19, 20, 21, 22 mm ○ Reversible Ratchet 870-1D Extension Bar 125 mm 870-35   Extension Bar 250 mm 870-55 Universal Joint 870-9	1	1340
0000412101000	OMS-21	same as OMS-34, but all sockets in hexagon pattern ○	1	1340
0000412107000	OMS-21/34L	empty module	1	80

### OMS-3/4

#### MODULE-SOCKET SET 1/2"

- for ELORA-roller tool cabinets
- black, with yellow signal colour
- oil and grease resistant
- chemical resistant
- Width: 41,0 cm, Depth: 18,9 cm
- hard foam insert

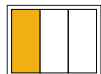
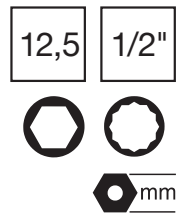

Code	Number	Contents	Pieces	Weight/g
0000410301000	OMS-3	Bi-Hexagon Sockets 770-LM 8, 9, 10, 11, 12, 13, 14, 15, 16, 17, 18,19, 20, 21, 22, 24, 25, 27, 30, 32 mm ○ Reversible Ratchet 770-L1D   Sliding T-Bar 770-L3 Extension Bar 125 mm 770-L5   Extension Bar 250 mm 770-L6   Universal Joint 770-L7	1	3420
0000410401000	OMS-4	same as OMS-3, but all sockets in hexagon pattern ○	1	3400
0000410307000	OMS-3/4L	empty module	1	80

### OMS-35/25

#### MODULE-SOCKET SET 3/4"

- for ELORA-roller tool cabinets
- black, with yellow signal colour
- oil and grease resistant
- chemical resistant
- Width: 41,0 cm, Depth: 37,7 cm
- hard foam insert

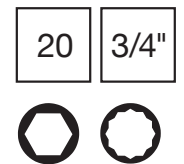

Code	Number	Contents	Pieces	Weight/g
0000413501000	OMS-35	Bi-Hexagon Sockets 770-S 22, 24, 27, 30, 32, 36, 38, 41, 46, 50 mm ○ Reversible Ratchet Head 770-S1K Extension Bar 200 mm 770-S4   Extension Bar 400 mm 770-S5 Tommy Bar 770-S7   Sliding Head 770-S13	1	9280
0000412501000	OMS-25	same as OMS-35, but all sockets in hexagon pattern ○	1	9280
0000412507000	OMS-25/35L	empty module	1	125

## OMS-24

### MODULE-IMPACT-SOCKET SET 1/2"

- for ELORA-roller tool cabinets
- black, with yellow signal colour
- oil and grease resistant
- chemical resistant
- Width: 41,0 cm, Depth: 18,9 cm
- hard foam insert

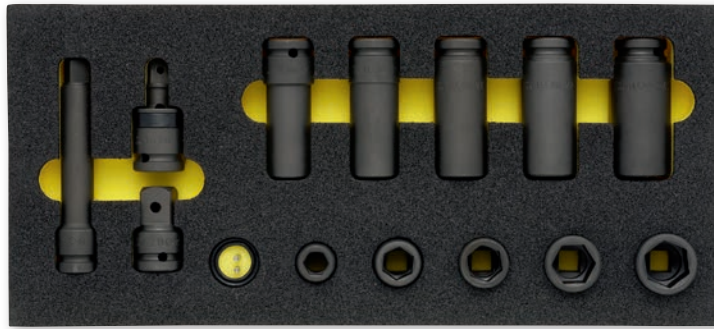

12,5

1/2"



Code	Number	Contents	Pieces	Weight/g
0000412401000	OMS-24	Impact Sockets 790-13, 17, 19, 22, 24 mm ○ Impact Sockets extra deep 790LT-17, 19, 21, 22, 24 mm ○ Impact Extension Bar 7901-125 Impact Adaptor 7902-3/4, 3/4" ■   1/2" ○ Impact Universal Joint 795 -1/2 Impact Locking pins 7903-20, 25   Impact Locking rings 7904-20, 24	1	2900
0000412407000	OMS-24L	empty module	1	80

## OMS-23

### MODULE-IMPACT-SOCKET SET 3/4"

- for ELORA-roller tool cabinets
- black, with yellow signal colour
- oil and grease resistant
- chemical resistant
- Width: 41,0 cm, Depth: 37,7 cm
- hard foam insert



20

3/4"

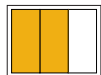
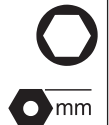

Code	Number	Contents	Pieces	Weight/g
0000412301000	OMS-23	Impact Sockets 791-24, 27, 30, 32, 36 mm ○ Impact Sockets extra deep 791LT-17, 19, 24, 27, 30, 32 mm ○ Impact Adaptor 7912-1/2, 1/2" ■   3/4" ○ Impact Universal Joint 795 -3/4 Impact Locking pins 7913-29, 37   Impact Locking rings 7914-28, 36	1	7780
0000412307000	OMS-23L	empty module	1	125

## OMS-18

### MODULE-TORX®-TOOLS

- for ELORA-roller tool cabinets
- black, with yellow signal colour
- oil and grease resistant
- chemical resistant
- Width: 41,0 cm, Depth: 18,9 cm
- hard foam insert

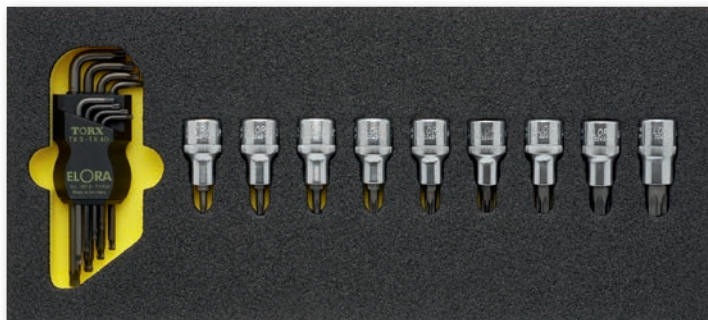

12,5

1/2"

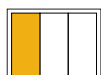

Code	Number	Contents	Pieces	Weight/g
0000411801000	OMS-18	Screwdriver Sockets for inside TORX® screws 3245 TX 20, 25, 27, 30, 40, 45, 50, 55, 60 ☉ TORX®-Ball End Key Set 162S-TXKU 9, 10, 15, 20, 25, 27, 30, 40 ✪	1	980
0000411807000	OMS-18L	empty module	1	80

## OMS-26

### MODULE HEXAGON KEY SET

- for ELORA-roller tool cabinets
- black, with yellow signal colour
- oil and grease resistant
- chemical resistant
- Width: 41,0 cm, Depth: 18,9 cm
- hard foam insert

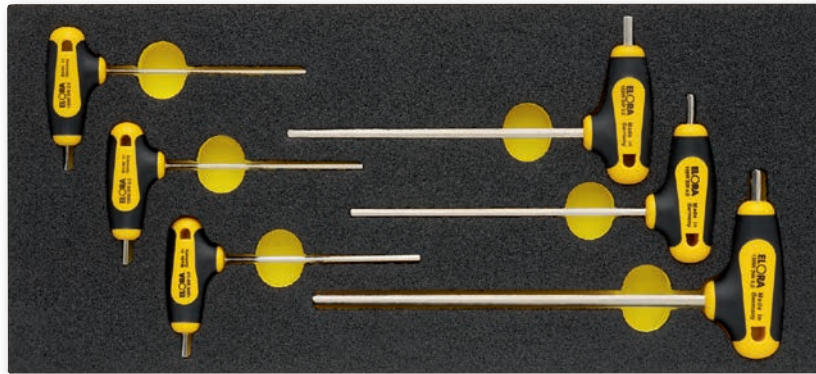

Code	Number	Contents	Pieces	Weight/g
0000412601000	OMS-26	Hexagon Key with T-Handle ● 159W-2, 2,5, 3, 4, 5, 6	1	340
0000412607000	OMS-26L	empty module	1	80

## OMS-27

### MODUL-TORX®-KEY SET WITH T-HANDLE

- for ELORA-roller tool cabinets
- black, with yellow signal colour
- oil and grease resistant
- chemical resistant
- Width: 41,0 cm, Depth: 18,9 cm
- hard foam insert

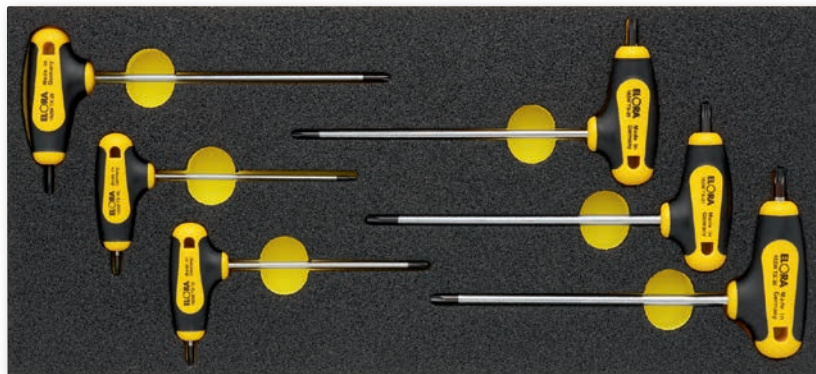

Code	Number	Contents	Pieces	Weight/g
0000412701000	OMS-27	TORX®-Key with T-Handle ★ 162WTX-10, 15, 20, 25, 27, 30	1	360
0000412707000	OMS-27L	empty module	1	80

## OMS-48

### MODULE-SCREWDRIVERS

- for ELORA-roller tool cabinets
- black, with yellow signal colour
- oil and grease resistant
- chemical resistant
- Width: 41,0 cm, Depth: 57,3 cm
- hard foam insert

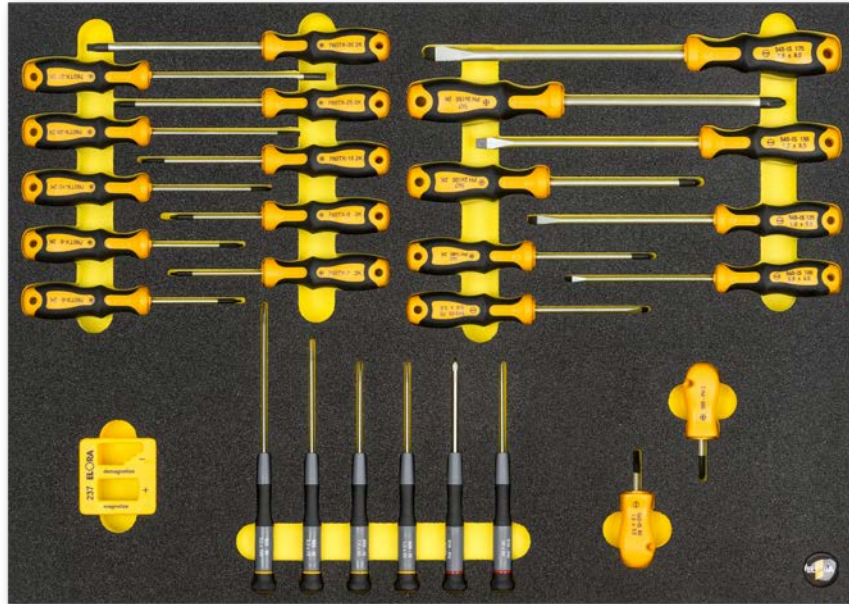

Code	Number	Contents	Pieces	Weight/g
0000414801000	OMS-48	QUATROLIT®-2C-Screwdriver for plain slotted screws                      545-IS 75 (0,6x3,5)   100 (0,8x4,0)   125 (1,0x5,5)   150 (1,2x6,5)   175 (1,6x8,0) Screwdriver for plain slotted screws, short version                      543-IS 60 (1,0x5,5) Screwdriver for cross slotted screws, short version                      555-PH 2 QUATROLIT®-2C-Screwdriver for cross slotted screws                      547-PH 1, 2, 3 Electronic Screwdriver for plain slotted screws                      600-IS 1,5x60, 1,8x60, 2,5x75, 3,0x100 Electronic Screwdriver for cross slotted screws                      610-PH 00, PH 0 Screwdriver for Inside TORX® screws                      760TX-6, 7, 8, 9, 10, 15, 20, 25, 27, 30 Magnetizer-Demagnetizer 237	1	1410
0000414807000	OMS-48L	empty module	1	160

## OMS-11

### MODULE-QUATROLIT®-2C-SCREWDRIVERS

- for ELORA-roller tool cabinets
- black, with yellow signal colour
- oil and grease resistant
- chemical resistant
- Width: 41,0 cm, Depth: 18,9 cm
- hard foam insert

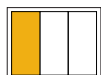
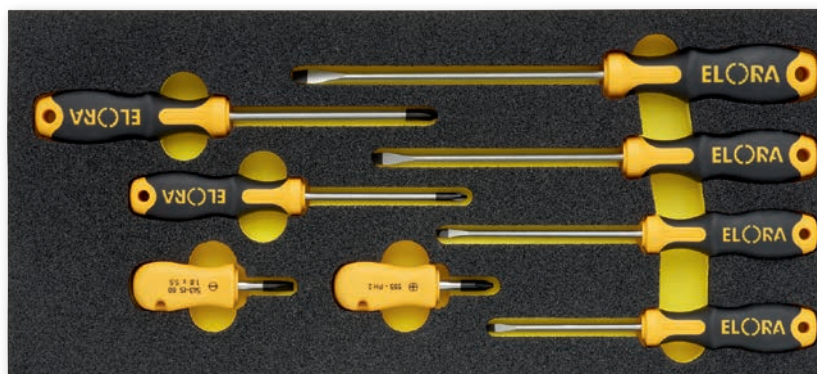

Code	Number	Contents	Pieces	Weight/g
0000411101000	OMS-11	QUATROLIT®-2C-Screwdriver for plain slotted screws 545-IS 75 (0,6x3,5)   100 (0,8x4,0)   125 (1,0x5,5)   150 (1,2x6,5)                      QUATROLIT®-2C-Screwdriver for cross slotted screws 547-PH 1, 2                      Screwdriver for plain slotted screws, short version 543-IS 45 (0,6x3,5)                      Screwdriver for cross slotted screws, short version 555-PH 1	1	485
0000411107000	OMS-11/38L	empty module	1	80



## OMS-6

### MODULE-QUATROLIT®-2C-SCREWDRIVERS

- for ELORA-roller tool cabinets
- black, with yellow signal colour
- oil and grease resistant
- chemical resistant
- Width: 41,0 cm, Depth: 18,9 cm
- hard foam insert

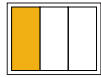

Code	Number	Contents	Pieces	Weight/g
0000410601000	OMS-6	QUATROLIT®-2C Screwdriver for plain slotted screws 539-IS 90 (0,8x4,0)   100 (1,0x5,5)   125 (1,2x6,5)   150 (1,2x8,0)   649-IS 75 (0,5x3,0) ⊖ QUATROLIT®-2C Screwdriver for cross slotted screws 559-PH 1, 2, 3 ⊕ Screwdriver for plain slotted screws, short version 543-IS 60 (1,0x5,5) ⊖ Screwdriver for cross slotted screws, short version 555-PH 1 ⊕	1	900
0000410607000	OMS-36L/37L	empty module	1	80

## OMS-7

### MODULE-QUATROLIT®-2C-SCREWDRIVERS

- for ELORA-roller tool cabinets
- black, with yellow signal colour
- oil and grease resistant
- chemical resistant
- Width: 41,0 cm, Depth: 18,9 cm
- hard foam insert



Code	Number	Contents	Pieces	Weight/g
0000410701000	OMS-7	QUATROLIT®-2C-Screwdriver for plain slotted screws 539-IS 90 (0,8x4,0)   100 (1,0x5,5)   125 (1,2x6,5)   150 (1,2x8,0) ⊖ QUATROLIT®-2C-Screwdriver for cross slotted screws 559-PH 1, 2, 3 ⊕ Screwdriver for plain slotted screws, short version 543-IS 60 (1,0x5,5) ⊖ Screwdriver for cross slotted screws, short version 555-PH 2 ⊕	1	900
0000410607000	OMS-36L/37L	empty module	1	80

## OMS-36

### MODULE-QUATROLIT®-2C-SCREWDRIVERS

- for ELORA-roller tool cabinets
- black, with yellow signal colour
- oil and grease resistant
- chemical resistant
- Width: 41,0 cm, Depth: 18,9 cm
- hard foam insert

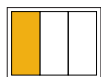

Code	Number	Contents	Pieces	Weight/g
0000413601000	OMS-36	QUATROLIT®-2C-Screwdriver for plain slotted screws 539-IS 90 (0,8x4,0)   100 (1,0x5,5)   125 (1,2x6,5)   150 (1,2x8,0) ⊖ QUATROLIT®-2C-Screwdriver for plain slotted screws 545-IS 75 (0,6x3,5) QUATROLIT®-2C-Screwdriver for cross slotted screws 569-PZ 1, 2, 3 ⊕ Screwdriver for plain slotted screws, short version 543-IS 60 (1,0x5,5) ⊖ Screwdriver for cross slotted screws, short version 554-PZ 2 ⊕	1	900
0000410607000	OMS-36L/37L	empty module	1	80

### OMS-37

#### MODULE-QUATROLIT®-2C-SCREWDRIVERS

- ▶ for ELORA-roller tool cabinets
- ▶ black, with yellow signal colour
- ▶ oil and grease resistant
- ▶ chemical resistant
- ▶ Width: 41,0 cm, Depth: 18,9 cm
- ▶ hard foam insert



Code	Number	Contents	Pieces	Weight/g
0000413701000	OMS-37	QUATROLIT®-2C-Screwdriver for plain slotted screws 539-IS 75 (0,6x3,5)   90 (0,8x4,0)   100 (1,0x5,5)   125 (1,2x6,5)   150 (1,2x8,0) ⇐ QUATROLIT®-2C-Screwdriver for cross slotted screws 569-PZ 1, 2, 3 ⇨ Screwdriver for plain slotted screws, short version 543-IS 60 (1,0x5,5) ⇐ Screwdriver for cross slotted screws, short version 554-PZ 2 ⇨	1	900
0000410607000	OMS-36L/37L	empty module	1	80

### OMS-38

#### MODULE-QUATROLIT®-2C-SCREWDRIVERS

- ▶ for ELORA-roller tool cabinets
- ▶ black, with yellow signal colour
- ▶ oil and grease resistant
- ▶ chemical resistant
- ▶ Width: 41,0 cm, Depth: 18,9 cm
- ▶ hard foam insert

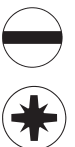
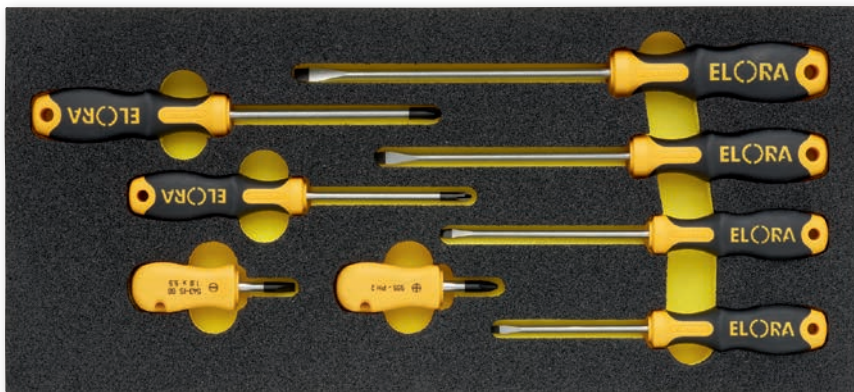

Code	Number	Contents	Pieces	Weight/g
0000413801000	OMS-38	QUATROLIT®-2C-Screwdriver for plain slotted screws 545-IS 75 (0,6x3,5)   100 (0,8x4,0)   125 (1,0x5,5)   150 (1,2x6,5) ⇐ QUATROLIT®-2C-Screwdriver for cross slotted screws 549-PZ 1, 2 ⇨ Screwdriver for plain slotted screws, short version 543-IS 45 (0,6x3,5) ⇐ Screwdriver for cross slotted screws, short version 554-PZ 1 ⇨	1	470
0000411107000	OMS-11/38L	empty module	1	80

### OMS-16

#### MODULE ENGINEER SCREWDRIVERS

- ▶ for ELORA-roller tool cabinets
- ▶ black, with yellow signal colour
- ▶ oil and grease resistant
- ▶ chemical resistant
- ▶ Width: 41,0 cm, Depth: 18,9 cm
- ▶ hard foam insert

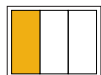
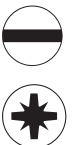
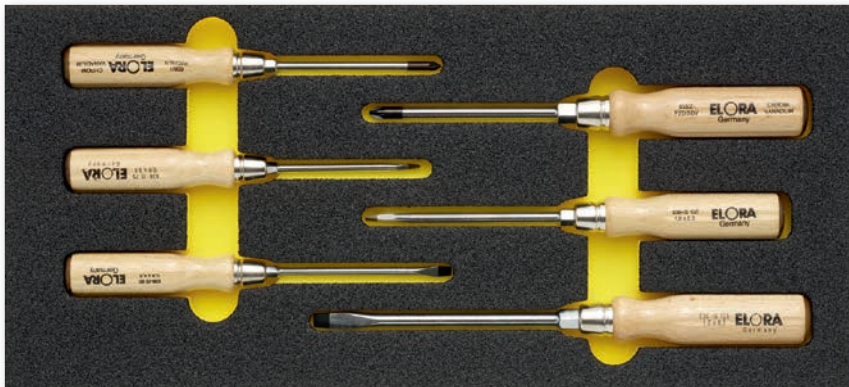

Code	Number	Contents	Pieces	Weight/g
0000411601000	OMS-16	Screwdriver for plain slotted screws with wooden handle ⇐ 636-IS 75 (0,6x3,5)   90 (0,8x4,5)   100 (1,0x5,5)   125 (1,2x6,5) Screwdriver for cross slotted screws with wooden handle ⇨ 658-PZ 1, 2	1	460
0000411607000	OMS-16L	empty module	1	80

## OMS-17

### MODULE ENGINEER SCREWDRIVERS

- for ELORA-roller tool cabinets
- black, with yellow signal colour
- oil and grease resistant
- chemical resistant
- Width: 41,0 cm, Depth: 18,9 cm
- hard foam insert

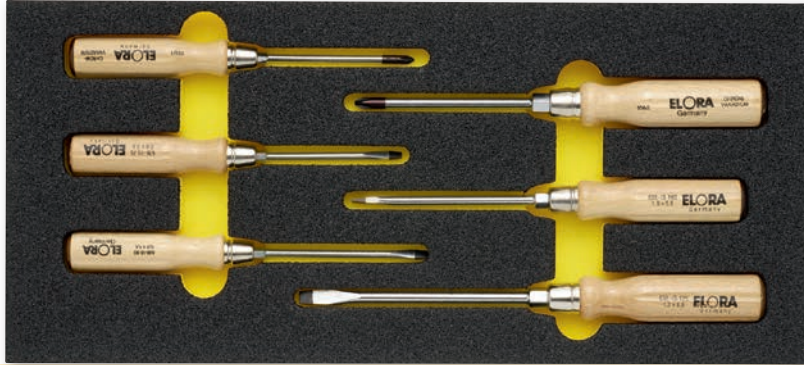

Code	Number	Contents	Pieces	Weight/g
0000411701000	OMS-17	Screwdriver for plain slotted screws with wooden handle  636-IS 75 (0,6x3,5)   90 (0,8x4,5)   100 (1,0x5,5)   125 (1,2x6,5) Screwdriver for cross slotted screws with wooden handle  656-PH 1, 2	1	460
0000411707000	OMS-17L	empty module	1	80

## OMS-43

### MODULE VDE SCREWDRIVERS

- for ELORA-roller tool cabinets
- black, with yellow signal colour
- oil and grease resistant
- chemical resistant
- Width: 41,0 cm, Depth: 18,9 cm
- hard foam insert

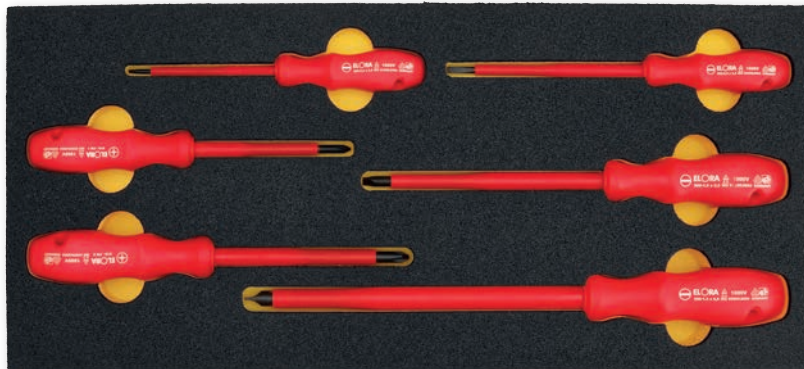

Code	Number	Contents	Pieces	Weight/g
0000414301000	OMS-43	VDE Screwdriver for plain slotted screws 900-IS 75 (0,4x2,5)   106 (0,6x3,5)   12510 (1,0x5,5)   175 (1,2x8,0) VDE Screwdriver for cross slotted screws 910-PH 1, 2	1	460
0000414307000	OMS-43L	empty module	1	80

## OMS-10

### MODULE-PLIERS

- for ELORA-roller tool cabinets
- black, with yellow signal colour
- oil and grease resistant
- chemical resistant
- Width: 41,0 cm, Depth: 18,9 cm
- hard foam insert

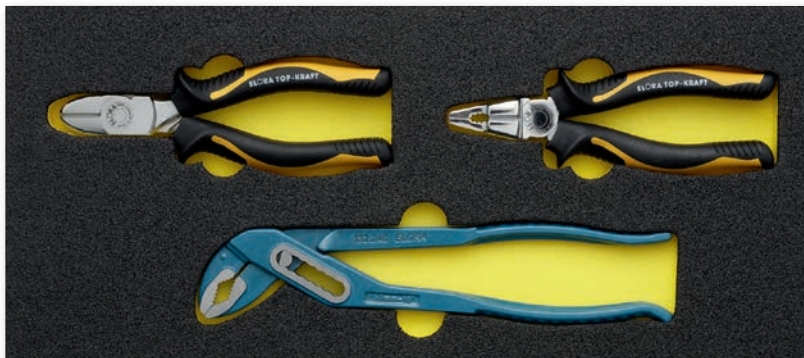

Code	Number	Contents	Pieces	Weight/g
0000411001000	OMS-10	Combination Plier, German pattern 495BI-165 Diagonal Cutter 492BI-160 Waterpump Plier 132-240	1	845
0000411007000	OMS-10L	empty module	1	80

## OMS-53

### MODULE-PLIERS

- for ELORA-roller tool cabinets
- black, with yellow signal colour
- oil and grease resistant
- chemical resistant
- Width: 41,0 cm, Depth: 57,3 cm
- hard foam insert



Code	Number	Contents	Pieces	Weight/g
0000415301000	OMS-53	Grip Plier with Wire Cutter, for round and flat material 500-250 Universal Scissors, straight 498-1 Heavy Duty Side Cutter 490BI-165 Snipe Nose Plier with side cutter, straight pattern Form 470BI-165 Combination Plier, German pattern 495BI-165 Waterpump Plier 132-240 Circlip Plier for internal Retaining Ring, straight jaws 473-J2 Circlip Plier for internal Retaining Ring, jaws bent at 90° 473-J21 Circlip Plier for external Retaining Ring, straight jaws 474-A2 Circlip Plier for external Retaining Ring, jaws bent at 90° 474-A21	1	2340
0000415307000	OMS-53L	empty module	1	160

## OMS-5

### MODULE-PLIERS

- for ELORA-roller tool cabinets
- black, with yellow signal colour
- oil and grease resistant
- chemical resistant
- Width: 41,0 cm, Depth: 18,9 cm
- hard foam insert

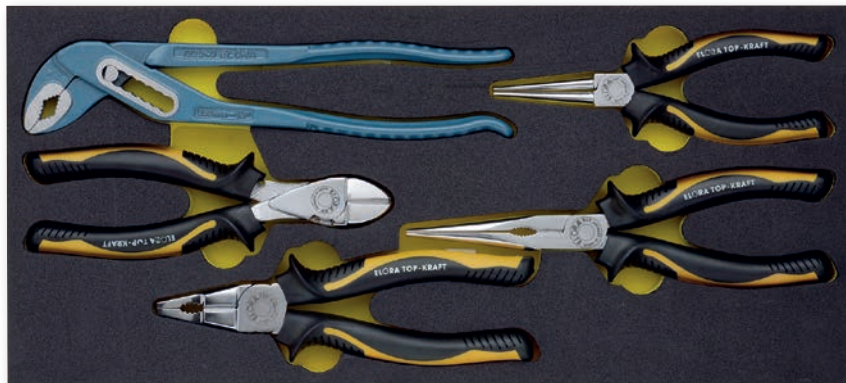

Code	Number	Contents	Pieces	Weight/g
0000410501000	OMS-5	Snipe Nose Plier with side cutter, straight pattern 470BI-200 Round Nose Plier with long jaws 477BI-170 Heavy Duty Side Cutter 490BI-165 Combination Plier, German pattern 495BI-185 Waterpump Plier 132-240	1	1200
0000410507000	OMS-5L	empty module	1	80

## OMS-42

### MODULE-VDE PLIERS

- for ELORA-roller tool cabinets
- black, with yellow signal colour
- oil and grease resistant
- chemical resistant
- Width: 41,0 cm, Depth: 18,9 cm
- hard foam insert

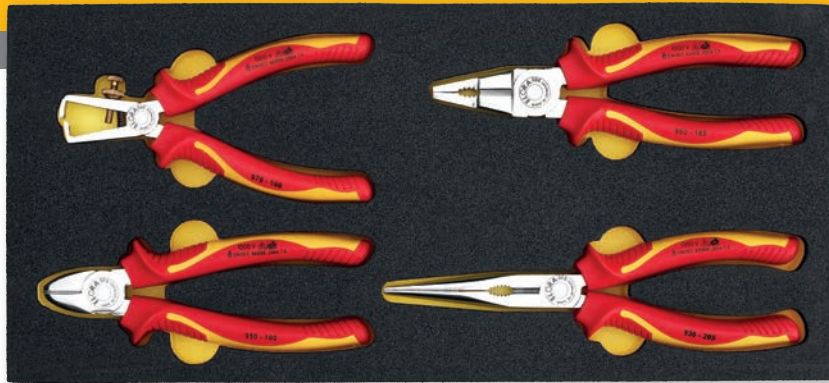

01

Code	Number	Contents	Pieces	Weight/g
0000414201000	OMS-42	VDE Universal Side Cutter with handle insulation 950-160 VDE Combination Plier with Handle Insulation 960-185 VDE Wire Stripper with Handle Insulation 970-160 VDE Snipe Nose Plier with Handle Insulation 930-205	1	900
0000414207000	OMS-42L	empty module	1	60

## OMS-20

### MODULE-CIRCLIP PLIER

- for ELORA-roller tool cabinets
- black, with yellow signal colour
- oil and grease resistant
- chemical resistant
- Width: 41,0 cm, Depth: 18,9 cm
- hard foam insert

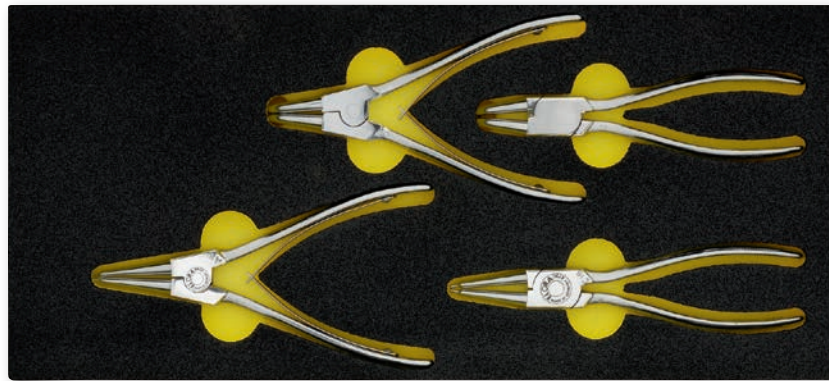

Code	Number	Contents	Pieces	Weight/g
0000412001000	OMS-20	Circlip Plier for internal Retaining Ring, straight jaws 473-J2 Circlip Plier for internal Retaining Ring, jaws bent at 90° 473-J21 Circlip Plier for external Retaining Ring, straight jaws 474-A2 Circlip Plier for external Retaining Ring, jaws bent at 90° 474-A21	1	650
0000412007000	OMS-20L	empty module	1	80

## OMS-12

### MODULE-HAND STRIKING TOOLS

- for ELORA-roller tool cabinets
- black, with yellow signal colour
- oil and grease resistant
- chemical resistant
- Width: 41,0 cm, Depth: 18,9 cm
- hard foam insert



Code	Number	Contents	Pieces	Weight/g
0000411201000	OMS-12	Flat Chisel, flat oval 260-200 Centre Punch 265-10 Parallel Pin Punch 271-2, 3, 4, 5, 6, 8 Engineer's Hammer, German Pattern 1665-500	1	1520
0000411207000	OMS-12L	empty module	1	80

## OMS-45

### MODULE-FILES AND HAND STRIKING TOOLS

- for ELORA-roller tool cabinets
- black, with yellow signal colour
- oil and grease resistant
- chemical resistant
- Width: 41,0 cm, Depth: 57,3 cm
- hard foam insert



Code	Number	Contents	Pieces	Weight/g
0000414501000	OMS-45	Flat Chisel, flat oval 260-200 Cape Chisel, flat oval 261-200 Centre Punch 265-10   Parallel Pin Punch 271-3, 4, 5, 6, 8 Three Square Hollow Ground Scraper 272-150 Engineers File 208-2x200 Rectangular File 246-2x200   Half Round File 247-2x200	1	4410
0000414507000	OMS-45L	empty module	1	160

## OMS-8

### MODULE-HAND STRIKING TOOLS

- for ELORA-roller tool cabinets
- black, with yellow signal colour
- oil and grease resistant
- chemical resistant
- Width: 41,0 cm, Depth: 18,9 cm
- hard foam insert

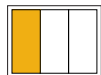

Code	Number	Contents	Pieces	Weight/g
0000410801000	OMS-8	Flat Chisel, flat oval 260-150 Flat Chisel, octagonal 262-150 Cape Chisel, flat oval 261-150	1	2200
0000410807000	OMS-8L	empty module	1	80

## OMS-54

### MODULE TESTING AND MEASURING TOOLS

- for ELORA-roller tool cabinets
- black, with yellow signal colour
- oil and grease resistant
- chemical resistant
- Width: 41,0 cm, Depth: 18,9 cm
- hard foam insert

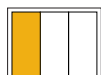





Code	Number	Contents	Pieces	Weight/g
0000415401000	OMS-54	Precision Vernier Caliper 1513 Thread Restoring File 258 MM Carbide Hexagon Engineer's Scriber 1592 Feeler Gauge 188-26M	1	755
0000415407000	OMS-54L	empty module	1	80

# WS OMS-5

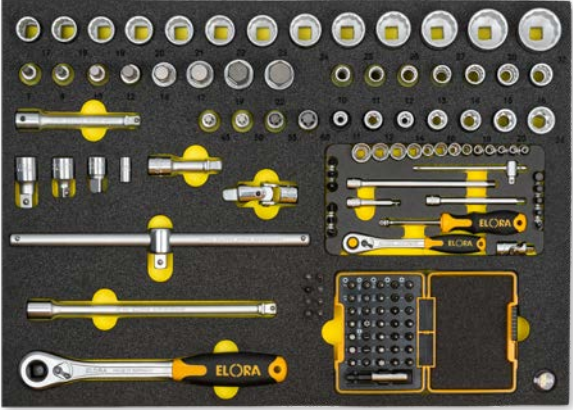
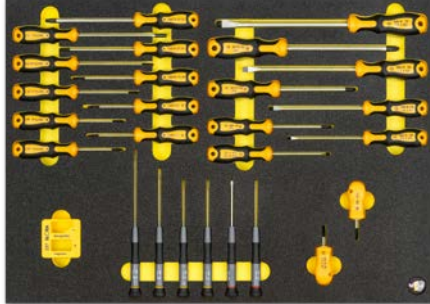
## INDUSTRIAL

► suitable for all Roller Tool cabinets and Work Bench 1811-L

Code	Number	Contents	Pieces	Weight/g
0000501220005	WS OMS-5	217 Tools	1 assortment	22710
<b>OMS-46</b>		 <p>1440-MU Socket Set 1/4", 30 pcs. ○ ● ⊖ ⊕            Bitbox 1/4", 36 pcs. ⊖ ⊕ ⊗ ⊙ ⊛ ⊜            Screwdriver Bit 1/4" for Inside TORX® Screws ★            3050-TX 6, 7, 8, TX 9, TX 10            Screwdriver Bit 1/4" for Inside TORX® Safety Screws ⊛            3070-TTX 10, 15, 27            Socket Converter 1/4" 1450-16, 1/4" ○   1/4" ○            Bihexagon Sockets 1/2" ○            770-LM 10, 11, 12, 13, 14, 15, 16, 17, 18, 19, 20, 21, 22, 23, 24, 25, 26, 27, 30, 32 mm            Reversible Ratchet 1/2" 770-L1D            Sliding T-Bar 1/2" 770-L3            Extension Bar 1/2" 50 mm 770-L35            Extension Bar 1/2", swivelling 75 mm 770-L4V            Extension Bar 1/2", swivelling 125 mm 770-L5V            Extension Bar 1/2", swivelling 250 mm 770-L6V            Universal Joint 1/2" 770-L7            Socket Converter 1/2" 770-L13, 3/8" ■   1/2" ○            Socket Converter 1/2" 770-L14, 1/2" ■   3/8" ○            Screwdriver Sockets 1/2" for inside Hexagon Screws ●            3210-IN 7, IN 8, IN 10, IN 12, IN 14, IN 17, IN 19, IN 22            Screwdriver Sockets 1/2" for Inside TORX® Screws ★            3245-TX 45, TX 50, TX 55, TX 60            Sockets 1/2" for Outside TORX® Screws ⊛            770-LTXE 11, 12, 14, 16, 18, 20, 24 mm</p>		
	123-pcs.			
<b>OMS-48</b>		 <p>QUATROLIT®-2C-Screwdriver for plain slotted screws ⊖            545-IS 75, 100, 125, 150, 175            Screwdriver for plain slotted screws, short version ⊖            543-IS 60            Screwdriver for cross slotted screws, short version ⊕            555-PH 2            QUATROLIT®-2C-Screwdriver for cross slotted screws ⊕            547-PH 1, 2, 3            Electronic Screwdriver for plain slotted screws ⊖            600-IS 1,5x60, 1,8x60, 2,5x75, 3,0x100            Electronic Screwdriver for cross slotted screws ⊕            610-PH 00, PH 0            Screwdriver for Inside TORX® screws ★            760TX-6, 7, 8, 9, 10, 15, 20, 25, 27, 30            Magnetizer-Demagnetizer 237</p>		
	27-pcs.			
<b>OMS-50</b>		 <p>Combination Spanners, cranked            205- 6, 7, 8, 9, 10, 11, 12, 13, 14, 15, 16, 17, 18, 19,            20, 21, 22, 23, 24, 25, 26, 27, 28, 30, 32 mm            Double Open-Ended Spanners DIN 3110            100- 6x7, 8x9, 10x11, 12x13, 14x15, 16x17, 18x19, 20x22,            21x23, 24x27, 25x28, 30x32 mm</p>		
	37-pcs.			
<b>OMS-53</b>		 <p>Grip Plier with Wire Cutter, for round and flat material 500-250            Universal Scissors, straight 498-1            Heavy Duty Side Cutter 490BI-165            Snipe Nose Plier with side cutter, straight pattern Form 470BI-165            Combination Plier, German pattern 495BI-165            Waterpump Plier 132-240            Circlip Plier for internal Retaining Ring, straight jaws 473-J2            Circlip Plier for internal Retaining Ring, jaws bent at 90° 473-J21            Circlip Plier for external Retaining Ring, straight jaws 474-A2            Circlip Plier for external Retaining Ring, jaws bent at 90° 474-A21</p>		
	10-pcs.			
<b>OMS-45</b>		 <p>Flat Chisel, flat oval 260-200            Cape Chisel, flat oval 261-200            Centre Punch 265-10            Parallel Pin Punch 271-3, 4, 5, 6, 8            Three Square Hollow Ground Scraper 272-150            Engineers File 208-2x200            Rectangular File 246-2x200            Half Round File 247-2x200            Round File 248-2x200            Cutter 281-P            Seal Flat Scraper 290            Rubber Mallet 1620-65            Engineer's Hammer, German Pattern 1665-300            Dead-Blow Nylon Soft Faced Hammer 1690-40            Mounting Bar 166            Measuring Tape 1546-3</p>		
	19-pcs.			

# WS OMS-6

## AUTOMOTIVE

► suitable for all Roller Tool cabinets and Work Bench 1811-L

01

Code	Number	Contents	Pieces	Weight/g
0000501220006	WS OMS-6	177 Tools	1 assortment	25990
<b>OMS-49</b>		<p>Bi-Hexagon Sockets ○            870- 7, 8, 9, 10, 11, 12, 13, 14, 15, 16, 17, 18, 19, 20, 21, 22 mm            Screwdriver Sockets ● 3510-IN 3, 4, 5, 6, 7, 8, 9, 10            Screwdriver Sockets long for inside hexagon screws ●            3510-INL 4x100, 5x100, 6x100, 8x100, 10x130            Screwdriver Sockets for inside-TORX® screws ★            3244-TX 15, 20, 25, 27, 30, 40, 45, 50            Screwdriver Sockets for inside multi-point B &amp; S and XZN screws ● 3530-XZN 5, 6, 8, 10            Screwdriver Sockets for Outside-TORX® screws ⊕ 870-TXE 10, 11, 12, 14            Reversible Ratchet 870-1D            Sliding T-Bar 870-8            Universal Joint 870-9            Extension Bar, swivelling 50 mm 870-3V   Extension Bar, swivelling 125 mm 870-35V            Extension Bar, swivelling 150 mm 870-4V            Socket Converter 870-10, 1/4" ■   3/8" ○   Socket Converter 770-L14, 1/2" ■   3/8" ○</p>		
53-pcs.				
<b>OMS-51</b>		<p>Combination Spanners, bent            203- 6, 7, 8, 9, 10, 11, 12, 13, 14, 15, 16, 17, 18, 19, 21, 22, 24, 27, 30, 32, mm            Double-Ended Ring Spanners, DIN 838            110- 6x7, 8x9, 10x11, 12x13, 14x15, 16x17, 18x19, 20x22, 21x23, 24x27, 25x28, 30x32 mm            Combination Spanner with Joint-Ring Ratchet            204R- 8, 9, 10, 11, 12, 13, 14, 15, 16, 17, 18, 19 mm            Adapter Drives for bits 1/4", 3/8", 1/2" und 1/4" Bit-Adaptor            118- 1, 2, 3, 4</p>		
48-pcs.				
<b>OMS-53</b>		<p>Grip Plier with Wire Cutter, for round and flat material 500-250            Universal Scissors, straight 498-1            Heavy Duty Side Cutter 490BI-165            Snipe Nose Plier with side cutter, straight pattern Form 470BI-165            Combination Plier, German pattern 495BI-165            Waterpump Plier 132-240            Circlip Plier for internal Retaining Ring, straight jaws 473-J2            Circlip Plier for internal Retaining Ring, jaws bent at 90° 473-J21            Circlip Plier for external Retaining Ring, straight jaws 474-A2            Circlip Plier for external Retaining Ring, jaws bent at 90° 474-A21</p>		
10-pcs.				
<b>OMS-47</b>		<p>Combination Spanner with Ring Ratchet, reversible 204-J 8, 10, 12, 13, 17, 19 mm ○            Double-Ended Ring Spanner for outside TORX®-Screws 119TXE- 6x8, 10x12, 14x18, 20x24 mm ⊕            Open Ring Spanner 121-10x11 mm ○            Adjustable Wrench 60-12 MB            Spark Plug Socket 1/2" ○             771-LTZ 16, 18, 20, 8 mm            Socket Converter 770-L14, 1/2" ■   3/8" ○            Impact Socket 1/2" ○ 790LTP-17, 19, 21 mm            Torque Wrench with Vernier Scale 2179-60   10-60 Nm, 2179-200   40-200 Nm            Engineer's Hammer, German Pattern 1665-500            Feeler Gauge 188-13 M            Tyre Lever 165-300, 165-500            Brush for Brake Service 293 BS            Seal Flat Scraper 290-1</p>		
39-pcs.				
<b>OMS-48</b>		<p>QUATROLIT®-2C-Screwdriver for plain slotted screws ⊖            545-IS 75, 100, 125, 150, 175            Screwdriver for plain slotted screws, short version ⊖            543-IS 60            Screwdriver for cross slotted screws, short version ⊕            555-PH 2            QUATROLIT®-2C-Screwdriver for cross slotted screws ⊕            547-PH 1, 2, 3            Electronic Screwdriver for plain slotted screws ⊖            600-IS 1,5x60, 1,8x60, 2,5x75, 3,0x100            Electronic Screwdriver for cross slotted screws ⊕            610-PH 00, PH 0            Screwdriver for Inside TORX® screws ★            760TX-6, 7, 8, 9, 10, 15, 20, 25, 27, 30            Magnetizer-Demagnetizer 237</p>		
27-pcs.				



### MS-2

#### MODULE-COMBINATION SPANNERS, CRANKED

- ▶ black, with transparent cover
- ▶ Width: 31,5 cm, Depth: 14,5 cm
- ▶ stable ABS plastic



Code	Number	Contents	Pieces	Weight/g
0000502001000	MS-2	Combination Spanners, cranked 205- 8, 10, 11, 13, 14, 17, 19, 22 mm	1	976
0000502007000	MS-2L	empty module	1	140

### MS-6

#### MODULE--COMBINATION SPANNERS, BENT

- ▶ black, with transparent cover
- ▶ Width: 31,5 cm, Depth: 14,5 cm
- ▶ stable ABS plastic



Code	Number	Contents	Pieces	Weight/g
0000506001000	MS-6	Combination Spanners, bent 203-8, 10, 11, 13, 17, 19, 22, 24 mm	1	1028
0000502007000	MS-2L	empty module	1	140

### MS-10

#### MODULE-COMBINATION SPANNER WITH RING RATCHET

- ▶ black, with transparent cover
- ▶ Width: 31,5 cm, Depth: 14,5 cm
- ▶ stable ABS plastic



Code	Number	Contents	Pieces	Weight/g
0000510001000	MS-10	Combination Spanners with Ring Ratchets 204- 8, 9, 10, 12, 13, 14, 17, 19 mm	1	940
0000502007000	MS-2L	empty module	1	140

## MS-50

### MODULE-SOCKET SET 1/4"

- black, with transparent cover
- Width: 31,5 cm, Depth: 14,5 cm
- stable ABS plastic



6,3

1/4"



Code	Number	Contents	Pieces	Weight/g
0000550001000	MS-50	Screwdriver Sockets for inside hexagon screws ★ 3243-TX 8, 9, 10, 15, 20, 25, 27, 30, 40 Sockets for outside TORX® screws ☼ 1455-TXE 4, 5, 6, 7, 8, 10, 11 Screwdriver Sockets for inside hexagon screws ● 1455-IN 3, 4, 5, 6, 8 mm Hexagon Sockets ○ 4, 4,5, 5, 5,5, 6, 7, 8, 9, 10, 11, 12, 13, 14 mm Reversible Ratchet 1450-1D Spinner Handle 1450-3 Sliding T-Bar 1450-4 Universal Joint 1450-8 Extension Bar 50 mm 1450-11 Extension Bar 100 mm 1450-5 Extension Bar 150 mm 1450-12	1	892
0000550007000	MS-50L	empty module	1	95

## MS-11/12

### MODULE-SOCKET SET 1/2"

- black, with transparent cover
- Width: 31,5 cm, Depth: 14,5 cm
- stable ABS plastic



12,5

1/2"



Code	Number	Contents	Pieces	Weight/g
0000511001000	MS-11	Bihexagon Sockets ○ 770-LM 10, 11, 12, 13, 14, 15, 16, 17, 18, 19, 20, 22 mm Reversible Ratchet 770-L1D Extension Bar 250 mm 770-L6 Sliding T-Bar 770-L3	1	2140
0000512001000	MS-12	same as MS-11, but all sockets in hexagon pattern ○	1	2140
0000511007000	MS-11L	empty module	1	95

### MS-14

#### MODULE-TORX®-TOOLS

- black, with transparent cover
- Width: 31,5 cm, Depth: 14,5 cm
- stable ABS plastic



12,5

1/2"



Code	Number	Contents	Pieces	Weight/g
0000514001000	MS-14	Screwdriver Sockets for inside TORX® screws ☸ 3245 TX 20, 25, 27, 30, 40, 45, 50, 55, 60 TORX®-Ball End Key Set ☸ 162S-TXKU 9, 10, 15, 20, 25, 27, 30, 40	1	918
0000513007000	MS-13L	empty module	1	95

### MS-13

#### MODULE-ALLEN KEYS SOCKET SET 1/2"

- black, with transparent cover
- Width: 31,5 cm, Depth: 14,5 cm
- stable ABS plastic



12,5

1/2"



mm

Code	Number	Contents	Pieces	Weight/g
0000513001000	MS-13	Screwdriver Socket 1/2" for Inside hexagon screws ● 3210 IN 4, 5, 6, 8, 10, 12, 14, 17, 19 mm Ball End Hexagon Key Set, extra long, 1,5-10 mm 159SKU	1	1486
0000513007000	MS-13L	empty module	1	95

### MS-38

#### MODULE-QUATROLIT® 2C-SCREWDRIVER

- black, with transparent cover
- Width: 31,5 cm, Depth: 14,5 cm
- stable ABS plastic



Code	Number	Contents	Pieces	Weight/g
0000538001000	MS-38	QUATROLIT®-2C-Screwdrivers for plain slotted screws ☰ 545-IS 75 (0,6x3,5)   100 (0,8x4,0)   125 (1,0x5,5)   150 (1,2x6,5) QUATROLIT®-2C-Screwdrivers for cross slotted screws ☩ 547-PH 1, 2	1	455
0000531007000	MS-31L/41L	empty module	1	96

### MS-39

#### MODULE-QUATROLIT® 2C-SCREWDRIVER

- black, with transparent cover
- Width: 31,5 cm, Depth: 14,5 cm
- stable ABS plastic



01

Code	Number	Contents	Pieces	Weight/g
0000539001000	MS-39	QUATROLIT®-2C-Screwdrivers for plain slotted screws ⊖ 545-IS 75 (0,6x3,5)   100 (0,8x4,0)   125 (1,0x5,5)   150 (1,2x6,5) QUATROLIT®-2C-Screwdrivers for cross slotted screws ⊕ 549-PZ 1, 2	1	456
0000531007000	MS-31L/41L	empty module	1	96

### MS-36

#### MODULE-QUATROLIT® 2C-SCREWDRIVER

- black, with transparent cover
- Width: 31,5 cm, Depth: 14,5 cm
- stable ABS plastic



Code	Number	Contents	Pieces	Weight/g
0000536001000	MS-36	QUATROLIT®-2C-Screwdrivers for plain slotted screws ⊖ 539-IS 75 (0,6x3,5)   100 (1,0x5,5)   125 (1,2x6,5)   150 (1,2x8,0) QUATROLIT®-2C-Screwdrivers for cross slotted screws ⊕ 559-PH 1, 2	1	574
0000531007000	MS-31L/41L	empty module	1	96

### MS-37

#### MODULE-QUATROLIT® 2C-SCREWDRIVER

- black, with transparent cover
- Width: 31,5 cm, Depth: 14,5 cm
- stable ABS plastic



Code	Number	Contents	Pieces	Weight/g
0000537001000	MS-37	QUATROLIT®-2C-Screwdrivers for plain slotted screws ⊖ 539-IS 75 (0,6x3,5)   100 (1,0x5,5)   125 (1,2x6,5)   150 (1,2x8,0) QUATROLIT®-2C-Screwdrivers for cross slotted screws ⊕ 569-PZ 1, 2	1	575
0000531007000	MS-31L/41L	empty module	1	96

### MS-40

#### MODULE-ENGINEER SCREWDRIVER

- black, with transparent cover
- Width: 31,5 cm, Depth: 14,5 cm
- stable ABS plastic



Code	Number	Contents	Pieces	Weight/g
0000540001000	MS-40	Screwdriver for plain slotted screws with wooden handle $\ominus$ 636-IS 75 (0,6x3,5)   90 (0,8x4,5)   100 (1,0x5,5)   125 (1,2x6,5) Screwdriver for cross slotted screws with wooden handle $\oplus$ 656-PH 1, 2	1	500
0000531007000	MS-31L/41L	empty module	1	96

### MS-41

#### MODULE-ENGINEER SCREWDRIVER

- black, with transparent cover
- Width: 31,5 cm, Depth: 14,5 cm
- stable ABS plastic



Code	Number	Contents	Pieces	Weight/g
0000541001000	MS-41	Screwdriver for plain slotted screws with wooden handle $\ominus$ 636-IS 75 (0,6x3,5)   90 (0,8x4,5)   100 (1,0x5,5)   125 (1,2x6,5) Screwdriver for cross slotted screws with wooden handle $\oplus$ 658-PZ 1, 2	1	500
0000531007000	MS-31L/41L	empty module	1	96

### MS-32

#### MODUL-VDE-SCREWDRIVER

- black, with transparent cover
- Width: 31,5 cm, Depth: 14,5 cm
- stable ABS plastic

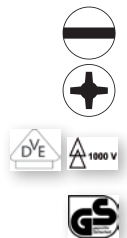

Code	Number	Contents	Pieces	Weight/g
0000532001000	MS-32	VDE-Screwdriver for plain slotted screws $\ominus$ 900-IS 75 (0,4x2,5)   106 (0,6x3,5)   12510 (1,0x5,5)   175 (1,2x8,0) VDE-Screwdriver for cross slotted screws $\oplus$ 910-PH 1, 2	1	518
0000531007000	MS-31L/41L	empty module	1	96

### MS-23

#### MODUL-VDE-PLIERS

- black, with transparent cover
- Width: 31,5 cm, Depth: 14,5 cm
- stable ABS plastic



01

Code	Number	Contents	Pieces	Weight/g
0000523001000	MS-23	VDE Combination Plier with Handle Insulation 960-185 VDE Snipe Nose Plier with Handle Insulation 930-205 VDE Universal Side Cutter with handle insulation 950-160	1	802
0000521007000	MS-21L	empty module	1	96

### MS-21

#### MODULE-PLIERS

- black, with transparent cover
- Width: 31,5 cm, Depth: 14,5 cm
- stable ABS plastic



Code	Number	Contents	Pieces	Weight/g
0000521001000	MS-21	Combination Plier, German pattern 495BI-185 Snipe Nose Plier with Side Cutter, straight pattern 470BI-200 Heavy Duty Side Cutter 490BI-165	1	806
0000521007000	MS-21L	empty module	1	96

## MS-25

### MODUL-CIRCLIP PLIER SET

- black, with transparent cover
- Width: 31,5 cm, Depth: 14,5 cm
- stable ABS plastic

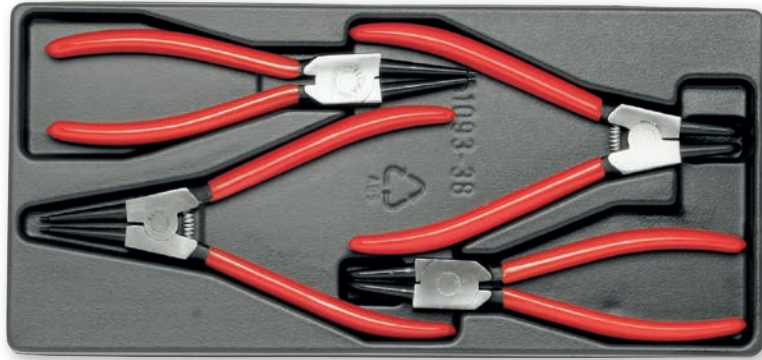

Code	Number	Contents	Pieces	Weight/g
0000525001000	MS-25	Circlip Plier for internal Retaining Ring, straight jaws 383-J2 Circlip Plier for internal Retaining Ring, jaws bent at 90° 383-J21 Circlip Plier for external Retaining Ring, straight jaws 384-A2 Circlip Plier for external Retaining Ring, jaws bent at 90° 384-A21	1	783
0000524007000	MS-25L	empty module	1	96

## MS-26

### MODUL-CIRCLIP PLIER SET

- black, with transparent cover
- Width: 31,5 cm, Depth: 14,5 cm
- stable ABS plastic

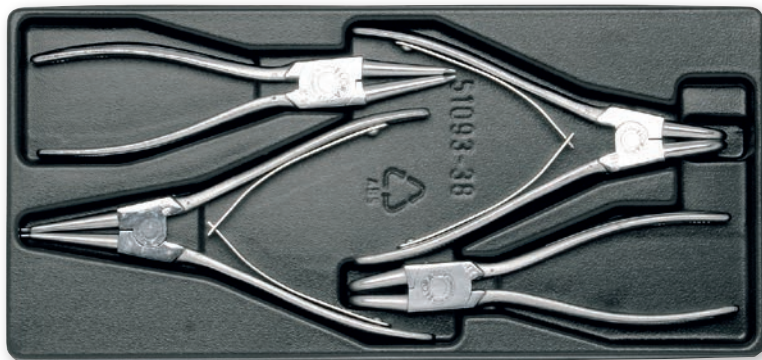

Code	Number	Contents	Pieces	Weight/g
0000526001000	MS-26	Circlip Plier for internal Retaining Ring, straight jaws 473-J2 Circlip Plier for internal Retaining Ring, jaws bent at 90° 473-J21 Circlip Plier for external Retaining Ring, straight jaws 474-A2 Circlip Plier for external Retaining Ring, jaws bent at 90° 474-A21	1	769
0000524007000	MS-25L	empty module	1	96





**WS-1M**
**TOOL ASSORTMENT**

- suitable for Tool Cabinet ELORA-No. 1100L
- suitable for all Roller Tool cabinets and Work Bench 1811-L

Code	Number	Contents	Pieces	Weight/g
0000500101000	WS-1M	64 metric tools	1 assortment	8300
<b>205-...</b>	8, 9, 10, 11, 12, 13, 14, 15, 16, 17, 19, 22 mm			
1 pc. each				
<b>770-LM...</b>	10, 11, 12, 13, 14, 15, 16, 17, 19, 22, 24, 27, 30, 32 mm			12,5 1/2"
1 pc. each				
<b>158R-1</b>	2; 2,5; 3; 4; 5; 6; 8; 10 mm			
1 pc. each				
<b>770-L1D</b>	270 mm			12,5 1/2"
1 pc. each				
<b>770-L3</b>	300 mm			12,5 1/2"
1 pc. each				
<b>770-L5/L6</b>	125 mm 250 mm			12,5 1/2"
1 pc. each				
<b>770-L7</b>	75 mm			12,5 1/2"
1 pc. each				
<b>539-IS...</b>	100, 125, 150			
1 pc. each				
<b>545-IS75</b>				
1 pc. each				
<b>547-PH...</b>	PH1 PH2 PH3			
1 pc. each				
<b>1665-300</b>				
1 pc. each				
<b>266-K</b>	262-125 mm 262-150 mm 263-125 mm 264-120x10x4 mm 264-120x12x4 mm 265-120x10mm			
1 pc. each				
<b>271-K</b>	271-150x2 mm 271-150x3 mm 271-150x4 mm 271-150x5 mm 271-150x6 mm 271-150x8 mm			
1 pc. each				
<b>132-240</b>				
1 pc. each				
<b>495-BI 165</b>				
1 pc. each				
<b>246-2x200</b>				
1 pc. each				
<b>247-2x200</b>				
1 pc. each				
<b>248-2x200</b>				
1 pc. each				

## WS-2...

### TOOL ASSORTMENT

- suitable for tool cabinet ELORA-No. 1100L
- suitable for all Roller Tool cabinets and Work Bench 1811-L
- suitable for cantilever tool box ELORA-Nr. 810-L

01

Code	Number	Contents	Pieces	Weight/g
0000500201000	WS-2M	89 metrische Werkzeuge	1 assortment	15000
0000600201000	WS-2A	88 inch tools	1 assortment	14500

MM-Assortment WS-2M		AF-Assortment WS-2A	
<b>100-...</b>	6x7, 8x9, 10x11, 12x13, 14x15, 16x17, 18x19, 20x22, 24x27, 30x32 mm		<b>100-...</b> 1/4x5/16, 5/16x3/8, 3/8 x7/16, 7/16x1/2, 1/2x9/16, 9/16x5/8, 5/8x11/16, 11/16x3/4, 3/4x7/8, 13/16x7/8, 15/16x1, 1.1/16x1.1/4 AF
je 1 Stück			je 1 Stück
<b>110-...</b>	6x7, 8x9, 10x11, 12x13, 14x15, 16x17, 18x19, 20x22, 24x27, 30x32 mm		<b>110-...</b> 1/4x5/16, 3/8x7/16, 1/2x9/16, 5/8x11/16, 3/4x25/32, 13/16x7/8, 15/16x1, 1.1/16x1.1/4 AF
je 1 Stück			je 1 Stück
<b>770-LM...</b>	10, 11, 12, 13, 14, 15, 16, 17, 18, 19, 21, 22, 24, 27, 30, 32 mm		<b>770-LM...</b> 3/8, 7/16, 1/2, 9/16, 19/32, 5/8, 11/16, 3/4, 13/16, 25/32, 7/8, 15/16, 1, 1.1/8, 1.1/4 AF
je 1 Stück			je 1 Stück
<b>158-R1</b>	2; 2,5; 3; 4; 5; 6; 8; 10 mm		<b>158-R1</b> 1/16, 5/64, 3/32, 1/8, 5/32, 3/16, 7/32, 1/4 AF
je 1 Stück			je 1 Stück
<b>188-13M</b>	0,05, 0,10, 0,15, 0,20, 0,25, 0,30, 0,40, 0,50, 0,60, 0,70, 0,80, 0,90, 1,00		<b>188-13M</b> .002, .003, .004, .005, .006, .008, .010, .012, .015, .020, .025, .030, .035
je 1 Stück			je 1 Stück

**One piece of each tool is included in both tool assortments WS-2M and WS-2A**

<b>770-L1D</b>	270 mm		1/2" 12,5	<b>490-BI 165</b>		
<b>770-L3</b>	300 mm		1/2" 12,5	<b>495-BI 185</b>		=
<b>770-L5/L6</b>	125 mm 250 mm		1/2" 12,5	<b>1660-32</b>		
je 1 Stück				<b>251-45</b>		
<b>770-L7</b>	75 mm		1/2" 12,5	<b>60-8A</b>		
<b>222-16x20,8</b>				<b>242KM-250</b>	250 ml	
<b>545-IS...</b>	75, 100, 125, 150, 200			<b>165-500</b>	2 Stück	
<b>547-PH...</b>	PH1 PH2 PH3			<b>189</b>		
je 1 Stück				<b>1546-3</b>		
<b>246-2x200</b>				<b>249 S6</b>		
<b>247-2x200</b>				<b>250-4</b>		
<b>248-2x200</b>				<b>266-K</b>	262-125, 150 mm 263-125 mm 264-120x10x4 mm 264-120x12x4 mm 265-120x10mm	
<b>132-240</b>				je 1 Stück		
<b>500-250</b>						
<b>1665-500</b>						
<b>470-BI 200</b>						

# WS-3M

## TOOL ASSORTMENT

- suitable for tool cabinet ELORA-No. 1100L
- suitable for all Roller Tool cabinets and Work Bench 1811-L
- suitable for cantilever tool box ELORA-Nr. 810-L

Code	Number	Contents	Pieces	Weight/g
0000500301000	WS-3M	80 metric tools	1 assortment	17500
<b>100-...</b>	6x7, 8x9, 10x11, 12x13, 14x15, 16x17, 18x19, 20x22, 21x23, 24x27, 25x28, 30x32 mm			
1 pc. each				
<b>110-...</b>	6x7, 8x9, 10x11, 12x13, 14x15, 16x17, 18x19, 20x22, 21x23, 24x27, 25x28, 30x32 mm			
1 pc. each				
<b>205-...</b>	8, 9, 10, 11, 13, 17, 19, 22 mm			
1 pc. each				
<b>770-LM...</b>	10, 11, 12, 13, 14, 15, 16, 17, 18, 19, 20, 21, 22, 23, 24, 25, 26, 27, 30, 32 mm			12,5 1/2"
1 pc. each				
<b>770-L1D</b>	270 mm			12,5 1/2"
<b>770-L3</b>	300 mm			12,5 1/2"
<b>770-L5/L6</b>	125 mm 250 mm			12,5 1/2"
1 pc. each				
<b>770-L7</b>	75 mm			12,5 1/2"
<b>222-16x20,8</b>				
<b>165-500</b>	2 pcs.			
<b>60-8A</b>				
<b>60-10A</b>				
<b>132-240</b>				
<b>470-BI 200</b>				
<b>490-BI 165</b>				
<b>495-BI 185</b>				
<b>473-J2</b>				IN
<b>473-J21</b>				IN
<b>539-IS...</b>	100, 125, 150, 200		1 pc. each	
<b>545-IS...</b>	75, 150		1 pc. each	
<b>547-PH...</b>	PH1 PH2		1 pc. each	
<b>260-150</b>				
<b>261-150</b>				
<b>265-10</b>				
<b>264-...</b>	264-120x10x2 mm 264-120x10x3 mm 264-120x12x4 mm 264-120x12x5 mm 264-120x12x6 mm		1 pc. each	
<b>1665-500</b>				
<b>246-2x200</b>				
<b>247-2x200</b>				
<b>248-2x200</b>				
<b>189</b>				

01

# WS-4M

## TOOL ASSORTMENT "MECHATRONIC"

- suitable for tool cabinet ELORA-No. 1100L
- suitable for all Roller Tool cabinets and Work Bench 1811-L
- suitable for cantilever tool box ELORA-Nr. 810-L
- suitable for hard protective case ELORA-No. 1380-L and hard protective trolley case ELORA-No. 1381-L

01

Code	Number	Contents	Pieces	Weight/g
0000500401101	WS-4M	131 metric tools	1 assortment	22800
<b>205-...</b>	6, 7, 8, 9, 10, 11, 12, 13, 14, 15, 16, 17, 18, 19, 20, 21, 22 mm			
1 pc. each				
<b>1455-M...</b>	4, 4.5, 5, 5.5, 6, 7, 8, 9, 10, 11, 13 mm			
1 pc. each		6,3 1/4"		
<b>770-LM...</b>	10, 11, 12, 13, 14, 15, 16, 17, 19, 22, 24, 27, 30, 32 mm			
1 pc. each		12,5 1/2"		
<b>159-...</b>	1.5, 2, 2.5, 3, 4, 5, 6, 8, 10, 12 mm			
1 pc. each				
<b>1450-1D</b>	145 mm		6,3 1/4"	
<b>1450-4</b>	270 mm		6,3 1/4"	
<b>1450-5</b>	100 mm		6,3 1/4"	
<b>1450-8</b>	45 mm		6,3 1/4"	
<b>1450-3</b>	150 mm		6,3 1/4"	
<b>1450-16</b>	25 mm		6,3 1/4"	
<b>770-L1D</b>	270 mm		12,5 1/2"	
<b>770-L3</b>	300 mm		12,5 1/2"	
<b>770-L5/L6</b>	125 mm 250 mm		12,5 1/2"	
1 pc. each				
<b>770-L7</b>	75 mm		12,5 1/2"	
<b>1080</b>				
<b>1513</b>				
<b>1591</b>				
<b>1543-3</b>				
<b>242KM-125</b>	125 ml			
<b>466A-16,0</b>				
<b>930-205</b>				
<b>960-185</b>				
<b>950-160</b>				
<b>900IS-...</b>	108, 12508			
1 pc. each				
<b>910PH-...</b>	PH1 PH2			
1 pc. each				
<b>564N</b>				
<b>561</b>				
<b>600-IS...</b>	1,2 x 60, 1,5 x 60 2,0 x 60			
<b>610-PH...</b>	00 x 60 0 x 60			
<b>4680-MH E</b>				
<b>4550-F E</b>				
<b>262-150</b>				
<b>265-10</b>				
<b>271-...</b>	3,0, 5,0			
1 pc. each				
<b>246-2x200</b>				
<b>207-2x200</b>				
<b>248-2x200</b>				
<b>189</b>				
<b>1665-500</b>				
<b>1690-30</b>				
<b>3436-S36</b>	Bit-Box 36 pcs.			

# WS-5M

## TOOL ASSORTMENT

- suitable for tool cabinet ELORA-No. 1100L
- suitable for all Roller Tool cabinets and Work Bench 1811-L

Code	Number	Contents	Pieces	Weight/g
0000500501100	WS-5M	145 metric tools	1 assortment	28600
<b>100-...</b>	6x7; 8x9; 10x11; 12x13; 14x15; 16x17; 18x19; 20x22; 21x23; 24x27; 25x28; 30x32 mm			
1 pc. each				
<b>110-...</b>	6x7; 8x9; 10x11; 12x13; 14x15; 16x17; 18x19; 20x22; 21x23; 24x27; 25x28; 30x32 mm			
1 pc. each				
<b>205-...</b>	8; 9; 10; 11; 12; 13; 14; 15; 16; 17; 18; 19; 20; 21; 22 mm			
1 pc. each				
<b>770-LM...</b>	10; 11; 12; 13; 14; 15; 16; 17; 18; 19; 21; 22; 23; 24; 25; 26; 27; 30; 32 mm		12,5 1/2"	
1 pc. each				
<b>1455-M...</b>	4; 4,5; 5; 5,5; 6; 7; 8; 9; 10; 11; 13 mm		6,3 1/4"	
1 pc. each				
<b>158R-1</b>	2; 2,5; 3; 4; 5; 6; 8; 10 mm			
1 pc. each				
<b>188-13M</b>	0,05; 0,10; 0,15; 0,20; 0,25; 0,30; 0,40; 0,50; 0,60; 0,70; 0,80; 0,90; 1,00			
1 pc. each				
<b>770-L1D</b>	270 mm		12,5 1/2"	
<b>770-L2</b>	300 mm		12,5 1/2"	
<b>770-L3</b>	300 mm		12,5 1/2"	
<b>770-L5/L6</b>	125 mm 250 mm		12,5 1/2"	
1 pc. each				
<b>770-L7</b>	75 mm		12,5 1/2"	
<b>1450-1D</b>	145 mm		6,3 1/4"	
<b>1450-3</b>	150 mm		6,3 1/4"	
<b>1450-4</b>	270 mm		6,3 1/4"	
<b>1450-5</b>	100 mm		6,3 1/4"	
<b>1450-8</b>	270 mm		6,3 1/4"	
<b>222-16x20,8</b>	16x20,8 mm			
<b>165-500</b>	500 mm			
2 pcs.				
<b>170-...</b>	170-24x27 mm 170-32x38 mm			
1 pc. each				
<b>171-500x18</b>	500 mm			
<b>195CV-17</b>	17; 19; 22 mm; 11/16" AF			
<b>60-...</b>	60-6A, 160mm / 6"; 60-8A, 210mm / 8"; 60-10A, 260mm / 10"			
1 pc. each				
<b>480-330</b>	330 mm			
<b>132-...</b>	132-190 mm, 132-240 mm			
1 pc. each				
<b>500-250</b>	250 mm			
<b>470-BI 200</b>	200 mm			
<b>471-45 BI 200</b>	200 mm			
<b>485-BI 165</b>	165 mm			
<b>490-BI 165</b>	165 mm			
<b>495-BI 185</b>	185 mm			
<b>473-J2</b>	180 mm			
<b>473-J21</b>	165 mm			
<b>474-...</b>	A2 A21			
1 pc. each				
<b>242KM-250</b>	250 ccm			
<b>539-IS...</b>	539-IS 100; 150; 200			
1 pc. each				
<b>545-IS...</b>	545-IS 75; 100; 150			
1 pc. each				
<b>543-IS 60</b>				
<b>555-PH1</b>				
<b>547-PH...</b>	547-PH 1; PH 2			
1 pc. each				
<b>260</b>	260-150 mm; 260-200 mm			
1 pc. each				
<b>261-150</b>	150 mm			
<b>264-...</b>	264-120x10x3; 120x12x4; 120x12x5; 120x12x6 mm			
1 pc. each				
<b>265-10</b>	120x10 mm			
<b>189</b>	420 mm			
<b>1665-300</b>	300 g			
<b>1665-35</b>				
<b>266-K</b>	262-125 mm, 262-150 mm 263-125 mm, 264-120x10x4 mm 264-120x12x4 mm, 265-120x10mm			
1 set				
<b>246-1x200</b>	200 mm/8"			
<b>247-2x200</b>	200 mm/8"			
<b>248-2x200</b>	200 mm/8"			
<b>352-S6</b>	Schraubenausdreher Satz 350-6; 8; 11; 14; 18; 24			
1 set				

# WS-6M

## TOOL ASSORTMENT

- suitable for tool cabinet ELORA-No. 1100L
- suitable for all Roller Tool cabinets and Work Bench 1811-L
- suitable for cantilever tool box ELORA-Nr. 810-L
- suitable for hard protective case ELORA-No. 1380-L and hard protective trolley Case ELORA-No. 1381-L
- suitable for installation tool bag ELORA-No. 1385-L

01

Code	Number	Contents	Pieces	Weight/g
0000500601000	WS-6M	83 metric tools	1 assortment	7800
<b>146-...</b>	4, 4,5, 5, 5,5, 6, 7, 8, 9, 10, 11, 12, 13, 14, 17 mm			
1 pc. each				
<b>113-...</b>	4x4,5, 5x5,5, 6x7, 8x9, 10x11 mm			
1 pc. each				
<b>1455-M...</b>	4, 4,5, 5, 5,5, 6, 7, 8, 9, 10, 11, 12, 13, 14 mm	<span>6,3</span> <span>1/4"</span>		
1 pc. each				
<b>158-R1</b>	2; 2,5; 3; 4; 5; 6; 8; 10 mm			
1 pc. each				
<b>216-...</b>	4, 4,5, 5, 5,5, 6, 7, 8, 9, 10 mm			
1 pc. each				
<b>1450-1D</b>	145 mm	<span>6,3</span> <span>1/4"</span>		
<b>1450-3</b>	150 mm	<span>6,3</span> <span>1/4"</span>		
<b>1450-4</b>	270 mm	<span>6,3</span> <span>1/4"</span>		
<b>1450-5</b>	100 mm	<span>6,3</span> <span>1/4"</span>		
<b>1450-8</b>	45 mm	<span>6,3</span> <span>1/4"</span>		
<b>132-240</b>				
<b>476-BI170</b>		<span>⊞</span>		
<b>477-BI170</b>		<span>●</span>		
<b>490-BI 165</b>		<span>⊗</span>		
<b>494-BI 160</b>		<span>⬥</span>		
<b>495-BI 165</b>		<span>⊞</span>		
<b>900IS-...</b>	75, 100, 7506, 108, 12510	<span>GS</span> <span>DVE</span> <span>1000 V</span>		
1 pc. each				
<b>910PH-...</b>	PH0, PH1, PH2	<span>GS</span> <span>DVE</span> <span>1000 V</span>		
1 pc. each				
<b>242K-60</b>	60 ml			
<b>237-500</b>				
<b>1665-100</b>				
<b>566-150</b>		<span>GS</span> <span>DVE</span> <span>1000 V</span>		
<b>1591-250</b>				
<b>257A</b>				
<b>740-...</b>	4,0, 5,5, 8,0	<span>⊞</span>		
1 pc. each				
<b>730-...</b>	1 + 3	<span>⊕</span>		
1 pc. each				
<b>271-...</b>	2, 3, 4, 5			
1 pc. each				

# WS-9M

## TOOL ASSORTMENT

- suitable for tool cabinet ELORA-No. 1100L
- suitable for all Roller Tool cabinets and Work Bench 1811-L
- suitable for cantilever tool box ELORA-Nr. 810-L
- suitable for hard protective case ELORA-No. 1380-L and hard protective trolley Case ELORA-No. 1381-L
- suitable for Installation tool bag ELORA-No. 1385-L
- suitable for cantilever tool box ELORA-Nr. 800-L, 810-L, 803-L, 813-L

01

Code	Number	Contents	Pieces	Weight/g
0000500901000	WS-9M	48 metric tools	1 assortment	5300
<b>203-...</b>	6, 7, 8, 10, 13, 15, 17, 19 mm			
1 pc. each				
<b>159-S-KK-1</b>	2,5, 3, 4, 5, 6, 8 mm			
1 pc. each				
<b>770-LM...</b>	10, 11, 12, 13, 14, 15, 16, 17, 18, 19, 20, 22			
1 pc. each		12,5 1/2"		
<b>251</b>				
<b>561</b>				
<b>586</b>				
<b>132-240</b>				
<b>1665-200</b>				
<b>260-150</b>				
<b>265-10</b>				
<b>271-4</b>				
<b>321-180</b>				
<b>470-BI200</b>				
<b>490-BI 165</b>				
<b>495-BI 185</b>				
<b>545-IS...</b>	75, 100, 125, 150			
1 pc. each				
<b>547-...</b>	PH1 PH2			
1 pc. each				
<b>770-L1D</b>	270 mm			
			12,5 1/2"	
<b>770-L3</b>	300 mm			
			12,5 1/2"	
<b>770-L6</b>	250 mm			
			12,5 1/2"	
<b>771-LTZ 20,8</b>				
			12,5 1/2"	

# WS-8M

## PLUMBING TOOL SET

- suitable for tool cabinet ELORA-No. 1100L
- suitable for all Roller Tool cabinets and Work Bench 1811-L
- suitable for hard protective case ELORA-No. 1380-L and hard protective trolley case ELORA-No. 1381-L
- suitable for cantilever tool box ELORA-Nr. 810-L

01

Code	Number	Contents	Pieces	Weight/g
0000500811001	WS-8M	58 metric tools	1 assortment	15000
<b>121-...</b>	8x10, 9x11, 12x14, 13x15, 14x16, 17x19, 21x23, 22x24 mm			
1 pc. each				
<b>204-...</b>	10, 11, 12, 13, 14, 15, 16, 17, 18, 19, 22, 24 mm			
1 pc. each				
<b>159-...</b>	1,5, 2, 2,5, 3, 4, 5, 6, 8, 10, 12 mm			
<b>770-L1ZI</b>	250 mm			
		12,5 1/2"		
<b>539-IS...</b>	100, 125, 150			
1 pc. each				
<b>559-PH...</b>	PH1 PH2			
1 pc. each				
<b>468-BI</b>				
<b>470-BI 165</b>				
<b>60-12MB</b>				
<b>68SN-1.1/2</b>				
<b>132-240</b>				
<b>301-250</b>				
<b>138</b>				
<b>131-250</b>				
<b>1665-500</b>				
<b>65-2</b>				
<b>179-16</b>				
<b>180-35</b>				
<b>64</b>				
<b>182-42</b>				
<b>365-200x8x10</b>				
<b>362-250</b>				
<b>283HS</b>				
<b>1544H</b>				
<b>561</b>				
<b>189P</b>				
<b>281-90</b>				
<b>1672-1250</b>				
<b>484R-260</b>				
<b>139-100</b>				



## WS-10M

### ELECTRICIAN TOOL SET

- suitable for tool cabinet ELORA-No. 1100L
- suitable for all Roller Tool cabinets and Work Bench 1811-L
- suitable for hard protective case ELORA-No. 1380-L and hard protective trolley case ELORA-No. 1381-L
- suitable for installation tool bag ELORA-No. 1385-L
- suitable for cantilever tool box ELORA-Nr. 810-L

01

Code	Number	Contents	Pieces	Weight/g
0000501101001	WS-10M	76 metric tools	1 assortment	5800
<b>100-...</b>	14x17, 18x19, 21x23, 22x24			
1 pc. each				
<b>146-...</b>	4, 4,5, 5, 5,5, 6, 7, 8, 9, 10, 11, 12, 13 mm			
1 pc. each				
<b>159-...</b>	1,5, 2, 2,5, 3, 4, 5, 6, 8, 10, 12 mm			
1 pc. each				
<b>1455-M...</b>	4, 4,5, 5, 5,5, 6, 7, 8, 9, 10, 11, 13 mm			
1 pc. each			6,3	1/4"
<b>1450-1D</b>	145 mm			
			6,3	1/4"
<b>1450-4</b>	270 mm			
			6,3	1/4"
<b>1450-5</b>	100 mm			
			6,3	1/4"
<b>1450-8</b>	45 mm			
			6,3	1/4"
<b>1450-3</b>	150 mm			
			6,3	1/4"
<b>543-IS 60</b>				
<b>555-PH1</b>				
<b>549-PZ...</b>	PZ1 PZ2			
1 pc. each				
<b>730-1</b>				
<b>740-...</b>	5,5 8,0			
1 pc. each				
<b>910PH-...</b>	PH1 PH2			
1 pc. each				
<b>900IS-...</b>	106, 108, 12508, 150			
1 pc. each				
<b>563</b>				
<b>960-185</b>				
				
<b>930-165</b>				
				
<b>920-165</b>				
				
<b>935-45</b>				
				
<b>970-160</b>				
				
<b>61-MB 10</b>				
<b>260-175</b>				
<b>264-...</b>	264-120x10x2 mm 1 pc. each 264-120x10x4 mm			
<b>265-10</b>				
<b>365-250x10x15</b>				
<b>1665-300</b>				
<b>132-240</b>				
<b>257-50</b>				
<b>257-S</b>	saw blade, universal			
<b>746</b>				
<b>1591-250</b>				
<b>281</b>				
<b>1546-3</b>				
<b>498-1</b>				